



SGE Syringe Selection Guide

www.sge.com



AUSTRALIA & PACIFIC REGION

CHINA

EUROPE

INDIA

JAPAN

MIDDLE EAST

USA



Welcome to the New SGE Analytical Science Syringe Selection Guide!

This is an exciting time for SGE with the introduction of the Diamond enhancements to the Syringe range – get ready to be dazzled by syringe brilliance! This new range is another development by SGE Analytical Science who began as a syringe manufacturer nearly 50 years ago. Now SGE Analytical Science manufactures a vast array of products used in chromatography and mass spectrometry.

SGE Analytical Science



SGE has achieved impressive success and growth since its founder Ernest Dawes established Scientific Glass Engineering in a tiny garage at the backyard of a house in Melbourne, Australia. Today, SGE has two modern facilities engaged in developing and manufacturing Chromatography and Analytical Products. SGE has nearly 400 employees, and a global distribution and support network. We are proud that all major analytical science instrument manufacturers rely on and incorporate SGE manufactured components in their systems. SGE has a commitment to quality and is an ISO accredited company. SGE is heavily committed to ongoing research and development that will allow the company to continue to bring innovative technologies and solutions to the scientific community.

About the SGE Syringe Selection Guide

The SGE Syringe Selection Guide is a complete reference for *finding, understanding and selecting* the best syringes and accessories to meet your particular needs. It's never been easier to select the right product and have technical performance data at your fingertips. We also want to share our expertise with you, so you'll find handy expert tips throughout the guide.

For more information on SGE's full range of products, including the world's most advanced electron multipliers, mass spectrometry components and innovative liquid and gas chromatography products, please visit our web site www.sge.com

SGE Syringe Design Capabilities

SGE syringes are consistently the choice of analytical equipment manufacturers and laboratories. Our customers choose SGE syringes because their reputation and results depend on the superior performance of our products.





SGE syringes are made to tight quality specifications resulting in accurate, precise and reliable syringes. All SGE products have two things in common:

- Outstanding performance.
- Superior quality.

SGE's knowledge and expertise in liquid handling technologies enables us to design syringes for a broad range of applications, such as nanoVolume sampling through to large volume air sampling - across diverse industries.

The SGE team is continually developing innovative ideas for products and technologies that make a difference for our customers.

Technical Support

For further detail on any SGE products, please contact our worldwide SGE technical support teams at your nearest SGE location, you'll find these listed on the back cover.

How to Order

So we can make ordering faster for you, please have this information ready:

- Part number.
- Description.
- Quantity.
- Purchase order number.

To order from SGE directly:

- Address and contact details of global SGE offices are listed on the back cover.

To order from your preferred SGE distributor:

- Address and contact details of our authorized distribution partners are listed on the SGE web site www.sge.com.

To order online:

- Visit www.sge.com



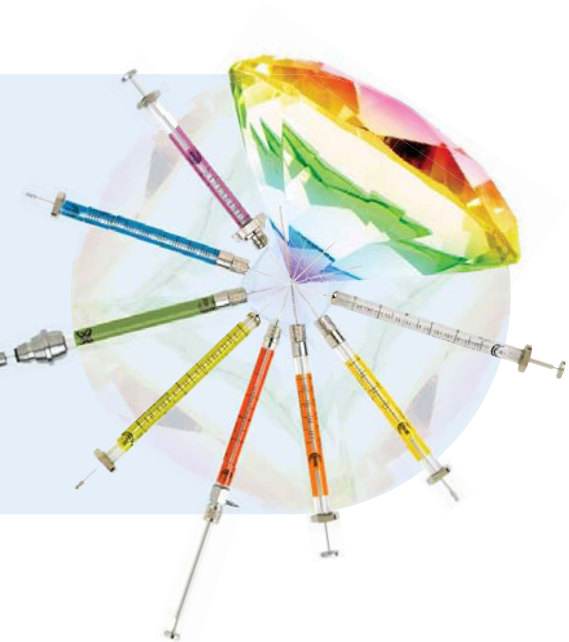

Table of Contents

	Page		Page
Syringe Selection	1	Syringe Valves	38
Technical Information	6	Syringes Pre-fitted with Syringe Valves	40
Syringe Care, Maintenance and Use	7	Valve Needles	40
Syringe Structure	9	SealTight™ Valves	41
Syringe Barrel Internal Diameter (ID)	9	GC Autosampler Syringes	42
Syringe Troubleshooting	10	Agilent Instruments	43
Syringe Validation and Calibration	11	CTC Analytics	45
What's New?	12	PerkinElmer Instruments	47
Diamond Syringe Technology	13	Shimadzu Instruments	48
XCHANGE®	16	Thermo Scientific Instruments	49
eVol® - Electronic Syringe	17	Unicam Instruments	50
General Purpose Manual Syringes	20	Varian Instruments	51
0.5 - 5 µL NanoVolume	21	LC Manual Syringes	52
5 µL and 10 µL Metal Plunger	23	Beckman/Altex, Rheodyne,	
25 - 500 µL Metal Plunger	25	SSI Instruments and Valco Valves	53
10 - 500 µL PTFE Tipped Plunger	26	Waters U6K Valves	55
1 - 100 mL PTFE Tipped Plunger	27	LC Autosampler Syringes	56
Special Purpose Syringes	28	Agilent Instruments	57
MEPS™ - Micro Extraction by		Hitachi Instruments	57
Packed Sorbent	29	CTC Analytics/Leap	58
On-Column	31	PerkinElmer Instruments	59
0.5 L to 2 L Jumbo	33	Spark Holland Instruments	59
Microsyringe/Pipette	34	Thermo Scientific Instruments	60
Gas Sealing Gland	35	Waters Instruments	61
Headspace/Soil Gas	36	LC Pump High Capacity Syringes	62
High Pressure	37		

	Page
Instrument Syringes	64
1 - 100 mL PTFE Tipped Plunger	65
General Instruments - Hamilton C and CX	66
Grabner, Shimadzu Total Organic Carbon Analyzer - TOC5000, Zymark	67
Syringe Accessories	68
Repeating Adaptor (RAX)	69
Syringe Racks	69
Heated Syringe Cleaner	70
Needle Cleaning Kit	71
Stylet Wires	71
Replacement Guide	72
Needles	73
NanoVolume Syringe Plunger and Needle Kits	75
Autosampler NanoVolume Syringes	76
Syringe Components	76
Plungers Listed by Syringe Part Number	77
Cross Reference guide	78
Hamilton Cross Reference	79
Index	82
By Part Number	83
By Product	86

Syringe Selection

Technical Information

What's New?



eVol®

General Purpose Manual Syringes

Special Purpose Syringes

Syringe Valves

GC Autosampler Syringes

LC Manual Syringes

LC Autosampler Syringes

LC Pump High Capacity Syringes

Instrument Syringes

Syringe Accessories

Replacement Guide

Cross Reference Guide

Index



Syringe Selection

SGE offers a complete range of syringes with a range of capacities, termination types, and numerous needle sizes for a wide range of applications. This selection guide explains the SGE syringe features and how to select the ideal syringe for any application.

Manual or Autosampler Syringe?

If the syringe is being used by hand, a manual syringe should be selected. If the syringe is installed in an instrument then select an autosampler syringe to suit that particular instrument.



SGE has a large range of manual syringes for use in chromatography and many other applications. SGE manual syringes have a bright white backing and contrasting black print making it easy to see the fluid level. This provides confidence that the right volume is being delivered every time.



SGE's extensive range of autosampler syringes meet all fit, form and function criteria of a specific autosampler model. As minimum requirements, they meet dimensional specifications, have accuracy of better than $\pm 1\%$ *, are designed for worry free overnight sampling, have extended life and are color coded by volume for easy identification of syringe volume.

* Plunger in barrel syringes.

What Size Syringe?

For the best possible injection reproducibility and accuracy, the smallest injectable volume from any syringe (with the exception of eVol®) should be no less than 10 % of its total capacity, for example: the smallest recommended injection volume from a 10 μL syringe would be 1 μL .

To accurately dispense 1 μL or less a NanoVolume syringe is recommended. SGE NanoVolume syringes are available with capacities ranging from 0.5 μL to 5 μL . These syringes can inject down to 0.05 μL because the entire sample is contained within the needle. Designed with submicron tolerances, these syringes are rugged, robust and reliable with virtually zero dead volume. Liquid and gas tight, they provide precision and accuracy of $\pm 2\%$.

- The typical scale length on a 0.5 μL – 10 μL syringe is 54.1 mm.
- The typical scale length on a 25 μL – 25 mL syringe is 60 mm.

Note: Scale length is sometimes referred to as stroke length or the travel of the plunger in one direction.

What is Termination?

Termination refers to the interface between the syringe barrel and its mating connection such as the needle. There are several different termination options to accommodate a wide range of applications.

Many syringes are supplied and used with needles attached; there are also other terminations available: Luer Lock, Luer Tip, and threaded terminations.



Luer Lock and Luer Tip fittings are a universal fitting with a male Luer taper made from KEL-F or PTFE to ISO standard 594. Luer Lock needles and fittings are used with syringes having Luer terminations. These syringes are often used with syringe filters and syringe pumps.

SGE offers both fixed and removable Luer Lock syringes. Fixed Luer Lock syringes have a Luer fitting that is permanently fixed to the barrel. If the Luer Tip is ever damaged, the syringe will need to be replaced. Removable Luer Lock syringes have Luer fittings that screw onto the barrel with the Luer Tip inserted. Luer tips and Luer fittings can be replaced if these are damaged. Removable Luer tips need to be tightened securely to ensure they do not come loose during use.

Syringes with threaded terminations screw into a valve or other device, and are required for some LC autosamplers, syringe pumps and dispensers. There are many thread terminations possible, contact SGE if you require a particular threaded termination that is not covered in this Selection Guide.

SGE's Termination Codes

- F Fixed Needle
- R Removable Needle
- LL Luer Lock
- LT Luer Tip

Which Needle?

Needle selection is based on application and personal choice.



Fixed needle.



Removable needle.

Fixed Needle or Removable Needle Syringes:

Fixed needle syringes are often the preferred option for experienced operators or for applications requiring trace sample levels. A fixed needle syringe is recommended for autosampler use where the probability of needle bending is minimal. Fixed needles are easy to use and the most economical syringe option. Fixed needle syringes can be heated in an oven up to 70 °C.

For versatility a removable needle syringe is recommended. The removable needle syringe reduces cost over time because only the needle needs to be replaced if bent or blocked. Removable needle syringes can be heated to 120 °C. Removable needle syringes allow the needle to be changed for different applications.

Refer to pages 73-75 for a listing of replacement needles.



SGE divides its removable needles into different ranges:

- 5 µL eVol®
- 5 µL
- 10 µL
- 25 µL to 500 µL (suitable for 50 µL eVol® Syringes)
- 1 mL to 2.5 mL (suitable for 500 µL eVol® Syringes)
- 5 mL to 10 mL
- Luer Lock
- Valve Needles

Needles can be easily changed to meet the application need. For example: a standard 10 µL removable needle syringe can be easily converted for LC or on-column use.

Gauge or Outer Diameter (OD):

To reduce the possibility of bending, choose the largest available needle outer diameter suitable for the application. For autosamplers, syringes with 23 gauge or 0.63 mm OD cone tipped needles should be selected for all applications except on-column injection.

Inner Diameter (ID):

The ID of the needle is selected to ensure minimal dead volume without compromising the ability of the syringe to draw normal viscosity samples. Medium to high viscosity samples should be diluted prior to use or a larger inside diameter needle selected.

Needle Tip Styles:

SGE has various needle tip styles to suit a range of applications and uses.



Bevel: Manual GC

The standard general purpose needle tip style supplied with many SGE syringes is a 20 ° bevel tip. It is the preferred option for manual injection where piercing the septum in exactly the same place is difficult. The bevel tip is designed for optimum septum penetration and prevention of septum coring. Bevel tip needles are also known as point style 2.



Cone: GC Autosampler

The cone shaped needle tip is specially developed to withstand the multi injection demands and improve septum lifetime when used with an autosampler. The cone design effectively “parts” the septum during piercing not cutting it, as would a bevel needle. Cone tip needles are also known as point style AS for autosampler.



Dual Gauge:

Dual gauge needles have a narrow gauge at the tip suitable for megabore on-column injection. The wider gauge for the remainder of the needle gives increased strength to the needle for autosampler use.



LC: HPLC

These needles are used for LC and HPLC valve injection and have a 90 ° square tip with rounded and polished edges. This eliminates damage to the valve's rotor seal and stator face. LC/HPLC tips are also known as point style 3.



Dome:

This style needle is recommended for use with pre-drilled septa. The tip is rounded and polished to help septum penetration.



Side Hole:

Samples are filled and dispensed through the side hole eliminating septum plugging of the needle. Ideal for large volume gas injection. The solid domed tip minimizes septum damage. Side hole/dome tips are also known as point style 5.



Sheathed/Bevel: Manual GC

This needle tip style is the same as the bevel tip, except a 0.7 mm OD reinforcing sheath is silver soldered over the standard needle to within 10 mm of the tip. The sheath provides exceptional strength to the needle. Sheathed/Bevel needles are also known as point style 4.

Syringe Selection



Metal or PTFE Tipped Plunger?

A syringe with a PTFE tipped plunger should be selected when analyzing “dirty” samples such as serum and urine. The PTFE tip minimizes carryover and prevents particulate matter from getting between the plunger and barrel by effectively wiping the barrel inner diameter during the plunger stroke. PTFE tipped plungers are suitable for both liquid and gas samples. Syringes with PTFE tipped plungers have the added benefit of the plungers being replaceable as the PTFE wears due to use.

Metal plungers are individually fitted to the syringe glass barrel for a perfect “feel”, optimized life with minimal carry over, a liquid tight seal between the barrel and plunger and excellent performance.

SGE Plunger Options:



Metal Plunger

- Stainless steel plunger individually fitted to its own syringe barrel.
- Plunger is not replaceable.
- Industry standard syringe for chromatography applications.
- For use when injection volume is greater than 1 μL .

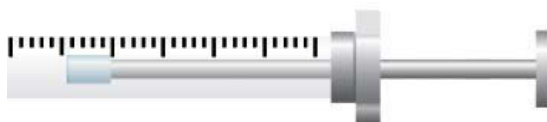

PTFE Tipped Plunger

- Suitable for both liquid and gas samples.
- Plunger is replaceable.
- Ideal for “dirty” samples.
- Suitable for gas or headspace applications.
- Easy to remove and clean to extend plunger life.
- Capacities: 10 μL to 100 μL .



NanoVolume (plunger-in-needle)

- Plunger extends into the needle tip.
- Sample is contained only in the needle, i.e. no glass contact.
- Ideal for dispensing very small liquid volumes.
- Recommended for use when sample volume is less than 1 μL .
- Capacities: 0.5 μL , 1 μL and 5 μL .

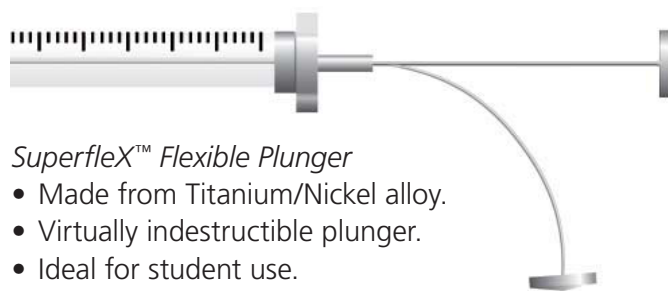

SuperfleX™ Flexible Plunger

- Made from Titanium/Nickel alloy.
- Virtually indestructible plunger.
- Ideal for student use.
- Capacities: 5 μL and 10 μL .



Plunger Protection

- Extended protection from the top of the syringe back flange to help prevent plunger bending during injection and improve plunger stroke.
- Ideal for general use for both experienced and inexperienced users.
- Capacities: 5 μL and 10 μL (not necessary for capacities larger than 10 μL due to strength of the wider plunger diameter).



Guided Plunger

- Extended barrel guides plunger during injection.
- Robust and rugged.
- Ideal for student use.
- Capacities: 5 μL and 10 μL .

Special Purpose Syringes

SGE makes a range of special purpose syringes:

- On-column syringes for direct injection into a GC column.
- Solid sample syringes for injecting solids when using SGE's Pyrojector II™.
- High-pressure syringes for HPLC and other applications where the syringe is exposed to elevated pressures.
- Jumbo syringes – 500 mL, 1 L and 2 L often used for air sampling.

Custom Needles and Syringes

If you are not able to find a needle or syringe to meet your needs please contact your local SGE distributor or office.

Technical Information



Technical Information | Syringe Care, Maintenance and Use

An SGE syringe is a precision instrument with a high standard of fit between the plunger and the glass barrel. Like most precision instruments, regular maintenance is important for ensuring long life and robust performance.

Syringes should be routinely checked for damage to the barrel and needle. Look for fine cracks in the barrel. Needles should also be checked for burrs and rough surfaces which may cause tearing and excessive wear on the septum.

Syringe Cleaning

Syringe cleaning agents will usually depend on the contaminating material. Methanol, methylene chloride, acetonitrile and acetone are commonly used.



Do not immerse the entire syringe in solvent as this may damage the adhesive used to bond parts of the syringe. Clean externally by wiping with a tissue.

Syringe Cleaning Steps:

1. Rinse thoroughly with suitable solvent.
2. Rinse with distilled water.
3. Flush with acetone.
4. Remove plunger and wipe with tissue.
5. Refit plunger and flush with acetone.
6. Allow syringe to dry.

Cleaning Steps for NanoVolume syringes can be found in the manual supplied with the syringe.

SGE Syringe Temperature Specifications

Heating will remove semi-volatile material from the syringe. Before heating or autoclaving remove the plunger.

- Fixed Needle and Fixed Luer Syringes can be heated in an oven to 70 °C.
- Removable Needle and Removable Luer Syringes can be heated in an oven to 120 °C.
- NanoVolume Syringes can be heated in an oven to 70 °C.

Rapid changes in temperature can lead to splitting of the glass barrel. Ensure heating and cooling of a syringe is a gradual process.

Plunger Care

Metal Plungers for Standard Syringes

- Never force the plunger.
- Do not pump the plunger when the needle is blocked as the high pressure generated could crack the barrel.
- Replacement metal plungers are not available. Plungers are individually fitted to the barrels to achieve a perfect seal. This means that plungers are not interchangeable.
- Avoid unnecessary movement of plungers when the syringe is dry.

Metal Plungers for NanoVolume Syringes

- Always loosen needle cover nut before removing or inserting plunger.
- Wipe plunger with a lint-free tissue before replacing into the syringe.
- A heated syringe cleaner is recommended for cleaning needles and plungers of NanoVolume syringes.

PTFE Tipped Plungers

- Avoid unnecessary movement of plungers when the syringe is dry.
- Replacement PTFE tipped plungers are available.

Needle Care

Unblocking needles:

1. To unblock the needle, remove the plunger and fill the syringe with solvent using another syringe.
2. Insert plunger and gently push solvent through the needle. Never force the plunger as too much pressure may crack the syringe barrel.

SGE Syringe Cleaning Accessories:



Needle Cleaning Kit (Part No. 031782): The kit contains a range of stylet wires for needle cleaning, tweezers and a surfactant material for barrel cleaning (see page 71).



Heated Syringe Cleaner (Part No. 031780, 031781): A heated syringe cleaner will remove organic residues from needles and is particularly useful for syringe cleaning when performing trace analysis (see page 70).

Syringe Use

- Always inspect the syringe before use. Check the barrel for cracks and the needle tip for burrs.
- To eliminate carryover between samples, flush the syringe with solvent 5-20 times, remembering to discard at least the first 2-3 washes.
- To eliminate air bubbles from the barrel, repeatedly draw and expel sample while keeping the needle tip immersed in the solution. Bubbles can also be removed by turning the barrel upright while expelling some of the sample. If bubbles persist, slow the aspiration speed.
- To make an injection, overfill the syringe then press the plunger until the correct volume is reached. Draw the plunger back slightly then wipe the needle tip with a lint free tissue. Make injection. For improved precision, syringes may be purchased fitted with a repeating adaptor, which allows the volume to be preset on the syringe.
- Before storage always rinse the syringe in solvent and air dry.

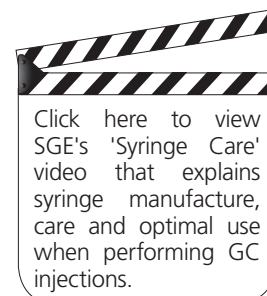

Click here to view SGE's 'Syringe Care' video that explains syringe manufacture, care and optimal use when performing GC injections.

Technical Information

Technical Information | Syringe Structure

Features of SGE Diamond syringes result in improved syringe lifetime and enhanced usability.

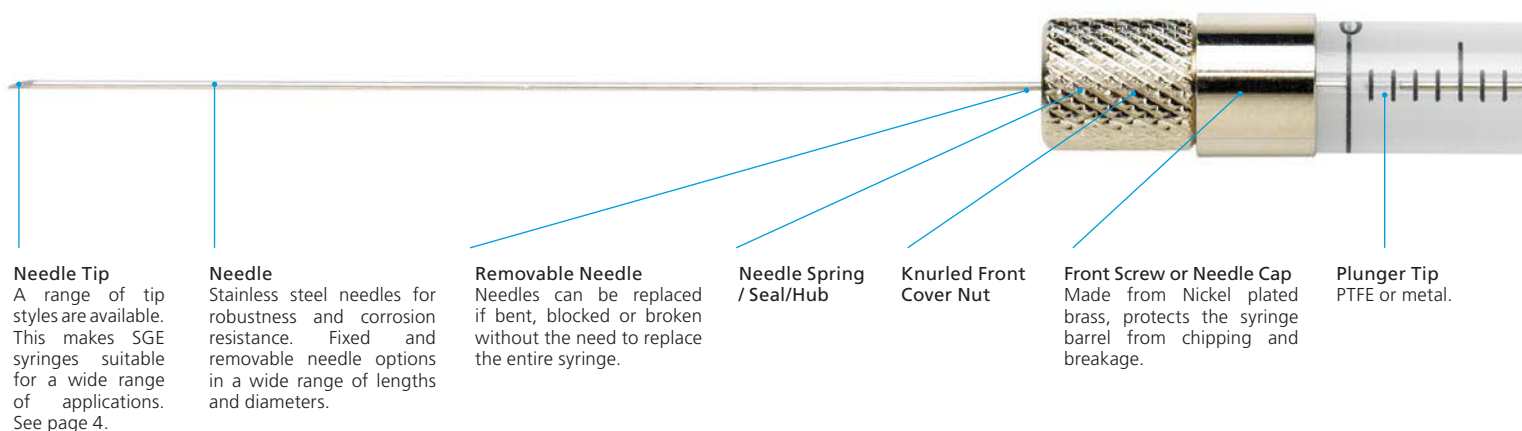

Technical Information | Syringe Barrel Internal Diameter (ID)

When using a syringe pump the internal diameter of the syringe barrel is required to calculate the pumping speed. The table below lists the internal diameters of SGE syringes based on volume.

Syringe Volume	5 μ L	10 μ L	25 μ L	50 μ L	100 μ L	250 μ L	500 μ L	1 mL
Internal Diameter of Syringe Barrel (mm)	0.343	0.485	0.728	1.030	1.457	2.303	3.257	4.606

Syringe Volume		2.5 mL	5 mL	10 mL	25 mL	50 mL	100 mL
Internal Diameter of Syringe Barrel (mm)		7.284	10.30	14.57	23.03	27.50	34.99



Backing Strip and Scale

Backing strip minimizes error when reading off scale.

Bright white backing with black scale markings on manual syringes for accurate reading of the syringe scale.

Color by volume on autosampler syringes for easy identification of installed syringes.

Scale is sharp, clear and easy to read – maximizes accuracy and precision.

Barrel

Made from borosilicate glass for robustness and solvent resistance.

Back Flange

Shape provides stability and prevents syringe rolling away, made from nickel plated brass to resist fracture.

Plunger Protection

Guides the plunger into the syringe. Helps to prevent plunger bending.

Plunger Stem

Plunger Button
Designed for easy syringe use or to fit appropriate autosampler.

Technical Information

Technical Information | Syringe Trouble Shooting

Problem	Cause	Solution
Blocked Needles	Improper cleaning.	Refer to syringe cleaning tips (page 7).
	Inappropriate needle selection.	Refer to needle selection guide (page 3).
Seized Plungers	Poor dispensing technique.	Ensure correct injection technique being followed.
	A build up of dirty samples.	Ensure correct syringe cleaning procedures are being followed (page 7).
	Syringe installed in autosampler incorrectly.	Ensure syringe installed correctly.
Poor Reproducibility	Incorrect syringe selection.	Refer to selection guide (page 1), the dispensed volume should be greater than 10 % of the entire syringe capacity.
	Poor operator technique.	Check that each sample is being injected in the same way.
	Incorrect instrument set up.	Check if any changes have been, or need to be made, to your instrument or set up (septa, injection port liner, etc).
Air Bubbles	Needle tip not fully immersed in sample or air being pulled up from sample by operator technique.	Repeatedly draw and expel sample while keeping needle tip immersed.
		Turning the syringe upright while expelling the sample may help in the removable of the bubble.
		Slow down.
Leakages	Leakage around needle due to needle fitted incorrectly.	Remove and refit the needle. Check seal is in place and undamaged.
	No seal at plunger tip –plunger tip damaged or worn due to use or using syringe dry.	Replace plunger assembly if using a PTFE tipped plunger.
Ghost Peaks	Dirty needle.	Between samples flush the syringe with solvent 5-20 times (discard at least the first 2-3 washes).
		Consider a heated syringe cleaner.



Technical Information | Syringe Validation and Calibration

If your laboratory is involved in GLP, ISO, GMP, NAMAS, ANSI, BSI or National Standards Protocol, then you will appreciate the importance of instrument calibration and its traceability. Although essential, this is often a time consuming, error prone and costly exercise to perform.

Certificate of Conformance

SGE supplies a syringe conformance certificate with every syringe to guarantee the syringe meets all specifications.

This syringe conformance certificate satisfies protocol requirements for syringes and provides traceability back to International Standards.

SGE syringes are produced in a manufacturing environment that operates under a quality management system that is independently certified in accordance with ISO9001:2008. All measuring equipment involved in production processes is calibrated and traceable to international standards and records are maintained. Through adherence to our quality system requirements SGE ensures that displacement volume will meet our specification for accuracy and reproducibility.

Certificate of Calibration

- Available for all SGE Syringes

SGE offers a factory calibration service, at an additional cost, for any syringe nominated by you at the time of purchase. These syringes are supplied with a Certificate of Calibration providing volume conformance and traceability. For identification each calibrated syringe is uniquely numbered and marked with this number.

Many companies attempt to calibrate syringes by measuring the mass of a dispensed volume. The accuracy of this technique is affected by many variables such as weighing errors, fluctuations in environmental temperature, pressure and evaporation, as well as operator error. Unlike competitors, which use these calibration techniques, SGE uses a superior technique of calibrated volume based on the length and diameter of the syringe barrel. Using specialized measuring equipment, SGE's calibration method has the highest degree of displacement volume accuracy and provides calibration traceability.

To order a calibrated syringe simply add 'CAL' to the end of the part number when ordering. For example; if you require a calibration certificate for a 002000, 10 µL fixed needle syringe; order part number 002000CAL.

SGE's eVol® – Digitally controlled analytical syringe, is the world's first user calibrated analytical syringe. Every eVol® is factory tested to ensure its operation complies with a comprehensive list of criteria. To achieve the highest level of accuracy possible each syringe may be calibrated. This will ensure your eVol® will dispense more accurately than any other manual syringe-based dispensing technique. A calibration factor for each syringe is used to adjust the software instructions controlling the motor to compensate for any slight variations in the positively displaced liquid volume. The calibration procedure for eVol® is based on a gravimetric measure of the volume dispensed from the eVol® (refer to page 17 for more details).

What's
New



What's New | Diamond Syringe Technology

Expert Tip :

The Diamond Syringe Technology improvements are standard across the SGE syringe range and are proven through extensive testing and continuous monitoring by SGE's quality systems.



SGE Analytical Science Diamond Syringe Technology offers a never before seen level of **durability, clarity** and **accuracy** in the laboratory. SGE Diamond syringes provide:

- Longest working life in the industry.
- Improved solvent resistance.
- Greater operational temperature range.
- Reduced dead volume and carry over.

Diamond Syringe Technology – Syringe Brilliance

Durability

Glass Surface Technology

SGE's innovative technology enhancements provide a smoother glass surface finish. This smoother surface dramatically improves syringe life by reducing the wear on the plunger.

The images below show the inside glass surface of an SGE Diamond Syringe (A) compared to a competitor's syringe (B). These images are magnified 20 times.

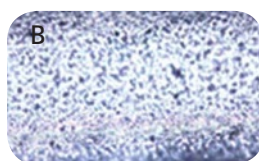

These improvements deliver longer syringe life and improved cycle life of up to 400 % over the classic SGE syringe.

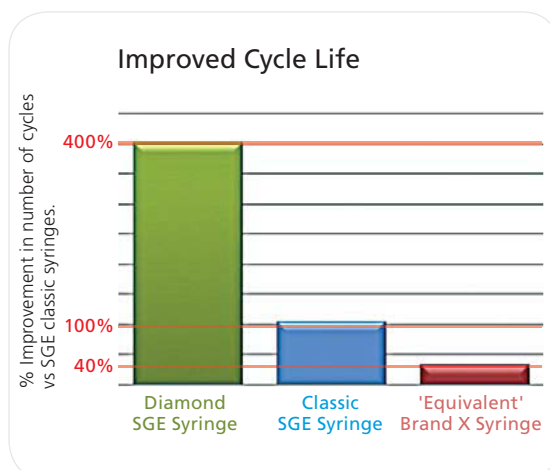

SGE Diamond Syringe removable needle hubs are permanently fused, greatly increasing their strength and ability to withstand higher temperatures.



Extensive testing shows the bond between the hub and the needle is even stronger than the needle itself. The risk of contamination and solvent attack is greatly reduced.



Chemical Compatibility

Materials used in the manufacture of SGE syringes are chosen to ensure the syringes are suitable for a wide range of applications.

- Borosilicate glass barrel for strength and inertness.
- Stainless steel needles – for inertness, strength and corrosion resistance.
- PTFE tipped plungers – for inertness and chemical resistance

Temperature Range of Syringes

- Fixed needle syringes can be heated in the oven to 70 °C.
- Removable needle syringes can be heated in the oven to 120 °C.

Clarity



The manual Diamond syringes have a bright white backing with contrasting black print for maximum readability and ease of use. The operator can easily see the scale ensuring the correct volume is delivered every time.



Autosampler and instrument syringes incorporate a vibrant new color scheme, distinguished by volume, enabling easy identification of syringes installed in instruments.

Color	Syringe Volumes			
Yellow	1000 nL (1 µL)		1 mL	1000 mL (1 L)
Grey		250 µL	2.5 mL	2000 mL (2 L)
Lime	5000 nL (5 µL)	5 µL	5 mL	
Dark Orange		10 µL	10 mL	
Green		25 µL	25 mL	
Purple		50 µL	50 mL	
Aqua		100 µL	100 mL	
Light Orange	500 nL (0.5 µL)	500 µL		500 mL (0.5 L)

What's New?



Accuracy

SGE Diamond syringes offer a new level of accuracy in the laboratory. SGE syringes eliminate areas where fluid can become trapped and potentially cause carryover. Carryover and dead volume are reduced by:

- **PTFE Plunger Tip Design**

The plunger tip used in PTFE tipped syringes eliminates areas where fluid can become trapped reducing dead volume and the chance of carryover or cross contamination. The tip sits flush against the insert further reducing the chance for carryover.

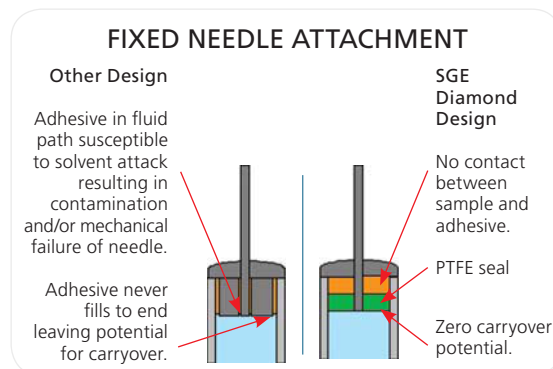

- **Fixed Needle Attachment Design**

A PTFE seal is added to separate fluid from adhesive. This reduces the chance of dead volume by eliminating areas where fluid can become trapped, and prevent carryover and any potential contamination from adhesives used to secure the needles.

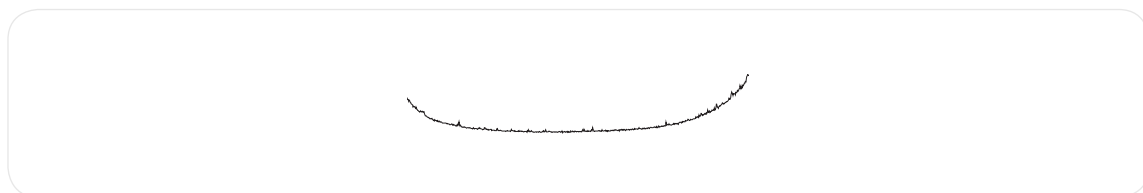

GC MS traces from SGE Diamond syringe.

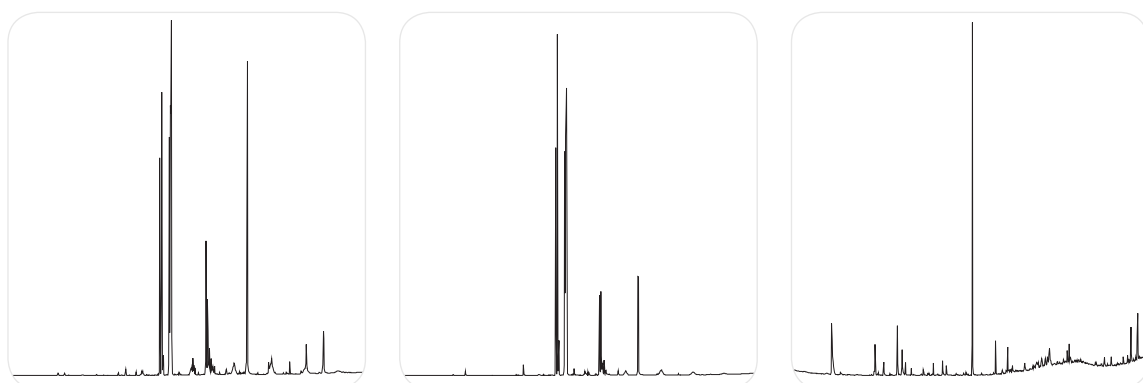

GC MS traces from three syringes currently available in the market showing peaks identified as being components of adhesives.

Syringe Packaging

SGE Diamond Syringe packaging is attractive, functional and easy to use. The packaging incorporates:

- Clear 100% recyclable protective inner syringe packaging.
- Box with window to allow easy identification of product through packaging.
- Fully recyclable outer box to contribute to a reduced environmental footprint.

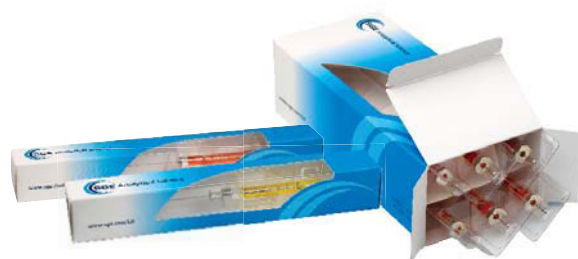

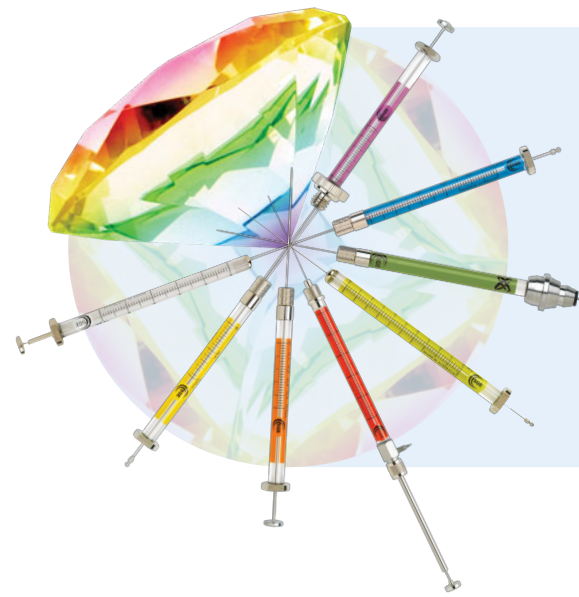

What's New | XCHANGE®*

XCHANGE® Robotic Connections



XCHANGE® (Patent Pending) is a coupling system easily integrated onto robotic platforms giving increased flexibility. It enables the

simple and automated exchange of a range of XCHANGE® analytical syringes and robotic tools.

XCHANGE® components are easily adapted to different style platforms for the ultimate flexibility - they are ideal on manual or semi-automated systems as a quick-change option.

eVol® World's 1st Digitally Controlled Analytical Syringe, is one of the first examples of XCHANGE® in use.

What's New?

The XCHANGE® coupling system secures and locks the syringe or tool in place. This is achieved by a mating mechanical piece that captures the syringe or tool, and a magnet that automatically aligns - eliminating the need for springs, screws, or alignment gauges. Once engaged the syringe or tool is locked into position requiring zero holding force.

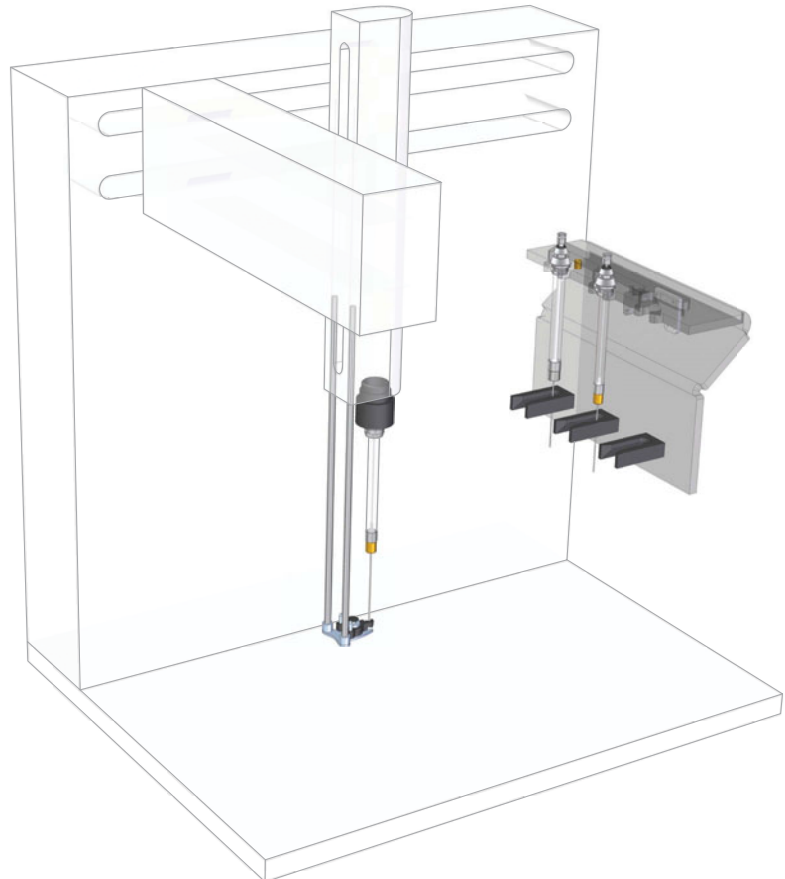

* Patent Pending





What's New | eVol®

eVol® - World's 1st Digitally Controlled Analytical Syringe

eVol® brings the technological advancements of laboratory liquid dispensing up to the levels seen elsewhere in the lab. eVol® is a complete dispensing solution with a broad range of functions and uses. eVol® revolutionizes the way laboratories work and the pace at which they process samples.

eVol® is the coupling of two precision devices: a digitally controlled electronic drive and an XCHANGE® (Patent Pending) enabled analytical syringe. See page 16 for further information on XCHANGE®. The result is a digitally controlled positive displacement dispensing system that can be programmed to reproducibly and accurately perform a wide variety of liquid handling procedures.

eVol® Improves Your Laboratory Workflow and Reporting Confidence

- The programmable digital drive accurately and precisely dispenses liquids independent of the user's skills - allowing more efficient workflow scheduling and a reduction in the re-analysis of incorrectly processed or false positive samples.
- XCHANGE® analytical syringes are easily and quickly changed allowing them to be dedicated to individual liquids to prevent possible cross-contamination of reagents.



eVol®

Every One an Expert

- To comply with stringent laboratory standards (e.g. GLP, GMP, FDA) eVol® is easily calibrated to ensure accurate dispensing at all times. eVol® is the world's first user calibrated analytical syringe. The gravimetric calibration procedure is simple, intuitive and can be performed at appropriate intervals. Calibration factors are stored for up to ten XCHANGE® syringes and quickly loaded when the syringe is changed.

Unlike air-displacement devices, eVol® is the perfect solution for accurately aspirating and dispensing both aqueous and non-aqueous liquids.



The three eVol® analytical syringe sizes can be used to accurately aspirate and dispense volumes covering a range from 200 nL to 500 µL.

- Accuracy \pm 0.2 % for a calibrated syringe at full scale.
- Precision RSD (%) at full scale:
 - eVol® 500 µL syringe 0.3 %.
 - eVol® 50 µL syringe 0.4 %.
 - eVol® 5 µL syringe 0.5 %.

The lightweight components and ergonomic design of the eVol® increases user comfort. Simple, one-handed operation minimizes handling time and exposure to hazardous substances.

eVol® features a Touch Wheel user interface and a full-color screen. The clever menu allows all the functions to be accessed logically and quickly. The programming functions are intuitive and include help screens and prompts.

Multiple operating modes maximize the flexibility of eVol® use:

- Dispense – aspirate and dispense the same volume.
- Repeat Dispense – repetitive dispensing of a desired volume.
- Manual – aspirate and dispense of varying volumes (i.e. titrations).
- Custom – create and store methods with parameters tailored to your solution (up to 98 steps).

Custom programs can be created tailoring methods that standardize laboratory work flows, improve efficiencies, reduce variation and better utilize laboratory staff. The automation of traditionally manual processes will increase throughput and generate valuable resource savings, highly sought after in commercial laboratories.

eVol® is powered by a rechargeable, long life, Lithium-ion Battery that provides approximately 3500 dispensing cycles between charges and can be used while charging.

Expert Tip:

Adjustable operational speed allows for variations in sample properties, such as viscosity and/or vapor pressure.



eVol®

APPLICATIONS

Typical applications for eVol® include:

- Preparation of calibration standards.
- Preparation and addition of internal standards.
- Precise dispensing of aqueous and non-aqueous liquids.
- Sample dilution.
- Instrument (GC and LC) injections.
- Serial dilutions.
- Micro titrations.
- TLC spotting.
- Routine dispensing.
- Precise measurements.
- Spiking.
- Quantitative NMR.





eVol® - Electronic Syringe

Part No.	Description
2910000	eVol® Electronic Syringe Starter Kit Contains: <ul style="list-style-type: none"> eVol® Electronic Syringe (handle). 3 eVol® Syringes - 5 µL, 50 µL and 500 µL. Stand. Universal Charger. Comprehensive Instruction Manual. Disc with Manual in Multiple languages.
2910005	eVol® Electronic Syringe (handle only)

eVol® XCHANGE® Syringes



Syringe Part No.	Description	Needle Length (mm)	Needle Gauge	Needle OD (mm)	Needle ID (mm)	Needle Tip	Replacement Needle Part No.	Replacement Plunger Part No.
2910020	5 µL	50	25	0.5	0.12	Bevel	036910	2910380
2910021	5 µL (supplied without needle)	-	-	-	-	-	-	2910380
2910022	50 µL	50	25	0.5	0.2	Bevel	038110 [∇]	2910382
2910023	50 µL (supplied without needle)	-	-	-	-	-	-	2910382
2910024	500 µL	50	25	0.5	0.2	Bevel	039110 [^]	2910384
2910025	500 µL (supplied without needle)	-	-	-	-	-	-	2910384
2910026	500 µL for MEPS™ applications*	-	-	-	-	-	-	2910384

[∇]All SGE 25 - 500 µL replacement needles can be used with 50 µL eVol® syringes. [^]All SGE 1 - 2.5 mL replacement needles can be used with 500 µL eVol® syringes. * The standard 50 µL eVol® syringe and 500 µL eVol® MEPS™ syringe can be used with the range of MEPS™ BINs. Please refer to page 30 for the listing of available MEPS™ BINs.

Replacement Needles for 5 µL eVol® XCHANGE® Syringes

Part No.	Description	Needle Length (mm)	Needle Gauge	Needle OD (mm)	Needle ID (mm)	Needle Tip	Pack Size
036910	Suitable for 5 µL eVol® Syringe	50	25	0.5	0.12	Bevel	5
036912	Suitable for 5 µL eVol® Syringe	51 (2")	22	0.028"	0.17	LC	5
036914	Suitable for 5 µL eVol® Syringe	50	23	0.63	0.11	Cone	5
036916	Suitable for 5 µL eVol® Syringe	70	25	0.50	0.20	Bevel	5
036918	Suitable for 5 µL eVol® Syringe	70	26	0.47	0.11	Cone	5

Replacement Needles for 50 µL and 500 µL eVol® XCHANGE® Syringes

Part No.	Description	Needle Length (mm)	Needle Gauge	Needle OD (mm)	Needle ID (mm)	Needle Tip	Pack Size
038110 [∇]	Suitable for 50 µL eVol® Syringe	50	25	0.5	0.2	Bevel	5
039110 [^]	Suitable for 500 µL eVol® Syringe	50	25	0.5	0.2	Bevel	5

[∇]All SGE 25 - 500 µL replacement needles can be used with 50 µL eVol® syringes. [^]All SGE 1 - 2.5 mL replacement needles can be used with 500 µL eVol® syringes. Refer to page 73 for replacement needles.

Accessories for eVol®



Part No. 2910010
eVol® Stand



Part No. 2910012
eVol® Universal Charger



Part No. 2910030
eVol® Charging Stand



Part No. 2910040
eVol® Replacement Battery

General Purpose Manual Syringes

SPECIFICATIONS

Accuracy and Reproducibility
 $\pm 2\%$ (dispensed volume)

Borosilicate Glass Barrel Outer Diameter (OD)
6.5 mm and 8 mm

Scale Length
54.1 mm (0.5 μL and 1 μL)
46.4 mm (5 μL)

International Standards Traceability

General Purpose Manual Syringes | 0.5 - 5 μL NanoVolume

With the ability to inject down to 50 nL with high precision and accuracy, SGE NanoVolume Syringes are perfect for NanoVolume capillary chromatography injection as well as making accurate standards that require small volumes.

The sample is only drawn into the needle, not the syringe barrel. When the plunger is depressed, the sample is completely dispensed by the NanoVolume plunger that extends to the tip of the needle.

Displacing the full sample during injection results in virtually zero dead volume and carry over between injections.

The plungers and needles are matched sets and must be replaced as a set. Refer to page 75 for a list of replacement plunger and needle kits.

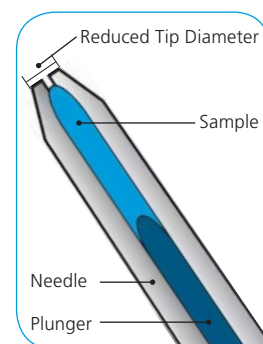

Nozzle tip shown in diagram.





Syringe Part No.	Syringe Volume	Needle Length (mm)	Needle Gauge	Needle OD (mm)	Needle ID (mm)	Needle Tip	Syringe Code	Replacement Needle and Plunger Part No.
6.5 mm Outer Diameter (OD) Barrel								
000300	0.5 µL	50	23	0.63	0.15	Cone	0.5BNR-5	033010
000301	0.5 µL	50	23	0.63	0.15	Bevel	0.5BNR-5BV	033011
000303	0.5 µL	50	26	0.47	0.15	Cone	0.5BNR-5/0.47	033012
8.0 mm Outer Diameter (OD) Barrel								
000310	0.5 µL	70	23	0.63	0.1	Cone	0.5BR-7	033057
000311	0.5 µL	70	23	0.63	0.1	Bevel	0.5BR-7BV	033060
000500	1 µL	50	23	0.63	0.15	Cone	1BR-5	034055
000501	1 µL	50	23	0.63	0.15	Bevel	1BR-5BV	034056
000505	1 µL	70	23	0.63	0.15	Cone	1BR-7	034057
000506	1 µL	70	23	0.63	0.15	Bevel	1BR-7BV	034060
000510	1 µL	115	23	0.63	0.15	Cone	1BR-11.5	034059
000570	1 µL	70	26	0.47	0.15	Cone	1BR-7/0.47	034610
000800	5 µL	50	23	0.63	0.37	Cone	5BR-5	035055
000801	5 µL	50	23	0.63	0.37	Bevel	5BR-5BV	035056
000802	5 µL	70	23	0.63	0.37	Cone	5BR-7	035057
000803	5 µL	70	23	0.63	0.37	Bevel	5BR-7BV	035058
000804	5 µL	115	23	0.63	0.37	Cone	5BR-11.5	035059
000805	5 µL	70	23	0.63	0.37	Nozzle	5BR-7N	035060

Expert Tip :

To eliminate carryover between samples, flush the syringe with solvent 5-20 times, remembering to discard the first 2-3 washes.



General Purpose Manual Syringes



Syringes Fitted with Repeating Adaptor

See page 69 for more details about the RAX repeating adaptor.

Syringe Part No.	Syringe Volume	Needle Length (mm)	Needle Gauge	Needle OD (mm)	Needle ID (mm)	Needle Tip	Syringe Code	Replacement Needle Part No.
6.5 mm Outer Diameter (OD) Barrel								
000350	0.5 µL	50	23	0.63	0.15	Cone	0.5BNR-5-RAX	033010
000353	0.5 µL	50	26	0.47	0.15	Cone	0.5BNR-5/47-RAX	033012
8.0 mm Outer Diameter (OD) Barrel								
000355	0.5 µL	70	23	0.63	0.1	Cone	0.5BR-7-RAX	033057
000550	1 µL	50	23	0.63	0.15	Cone	1BR-5-RAX	034055
000553	1 µL	70	23	0.63	0.15	Cone	1BR-7-RAX	034057

Expert Tip:

When replacing the plunger and needle follow the instructions included in the kit – the front cover nut must be loosened before removing the plunger.



SPECIFICATIONS

Accuracy and Reproducibility
± 1 % (dispensed volume)

Borosilicate Glass Barrel Outer Diameter (OD)
6.5 mm and 8 mm

Scale Length
54.1 mm

International Standards Traceability

General Purpose Manual Syringes | 5 - 10 µL Metal Plunger

Standard Plunger Protection Syringes

Syringe Part No.	Syringe Volume	Needle Length (mm)	Needle Gauge	Needle OD (mm)	Needle ID (mm)	Needle Tip	Syringe Code	Replacement Needle Part No.	6 Pack Part No.	10 Pack Part No.	25 Pack Part No.
Fixed Needle											
001000	5 µL	50	26	0.47	0.11	Bevel	5F	-	-	-	-
001002	5 µL	70	26	0.47	0.11	Bevel	5F-7	-	-	-	-
002000	10 µL	50	26	0.47	0.11	Bevel	10F	-	002030	002033	002035
002003	10 µL	70	26	0.47	0.11	Bevel	10F-7	-	-	-	-
002005	10 µL	50	26	0.47	0.11	cone	10F-5C	-	-	-	-
002007	10 µL	115	26	0.47	0.11	Bevel	10F-11.5	-	-	-	-
Removable Needle											
001050	5 µL	50	26	0.47	0.11	Bevel	5R	-	-	-	-
002050	10 µL	50	26	0.47	0.11	Bevel	10R	037110	002080	-	-
002055	10 µL	70	26	0.47	0.11	Bevel	10R-7	037130	-	-	-



Expert Tip:

Plunger protection prevents plunger bending during injection.



SuperFlex™ Syringes

Syringe Part No.	Syringe Volume	Needle Length (mm)	Needle Gauge	Needle OD (mm)	Needle ID (mm)	Needle Tip	Syringe Code	Replacement Needle Part No.	6 Pack Part No
Fixed Needle									
001100	5 µL	50	26	0.47	0.11	Bevel	5FX	-	-
001105	5 µL	50	26	0.47	0.11	Cone	5FX-5C	-	-
002100	10 µL	50	26	0.47	0.11	Bevel	10FX	-	002130
002101	10 µL	70	26	0.47	0.11	Bevel	10FX-7	-	-
002105	10 µL	50	26	0.47	0.11	Cone	10FX-5C	-	002133
002108	10 µL	50	23	0.63	0.11	Cone	10FX-5/0.63C	-	002135
Removable Needle									
001150	5 µL	50	26	0.47	0.11	Bevel	5RX	036110	-
002150	10 µL	50	26	0.47	0.11	Bevel	10RX	037110	002180

Expert Tip :



The virtually indestructible titanium nickel alloy plunger of the SuperFlex™ Syringes is ideal for student use.



Guided Plunger Syringes

Syringe Part No.	Syringe Volume	Needle Length (mm)	Needle Gauge	Needle OD (mm)	Needle ID (mm)	Needle Tip	Syringe Code	Replacement Needle Part No.	6 Pack Part No
Fixed Needle									
001400	5 µL	50	26	0.47	0.11	Bevel	5F-GP	-	-
002400	10 µL	50	26	0.47	0.11	Bevel	10F-GP	-	-
Removable Needle									
001450	5 µL	50	26	0.47	0.11	Bevel	5R-GP	036110	-
001455	5 µL	70	26	0.47	0.11	Bevel	5R-GP-7	036130	-
001495*	5 µL	50	26	0.47	0.11	Bevel	5R-GPS	037110	-
002450	10 µL	50	26	0.47	0.11	Bevel	10R-GP	037110	-
002453	10 µL	70	26	0.47	0.11	Bevel	10R-GP-7	037130	-

* Short half scale syringe (scale length 27 mm, barrel outer diameter OD 8 mm).

Expert Tip :



Guided plunger syringes are the most rugged syringe available. Making them perfect for industrial environments.



General Purpose Manual Syringes



Syringes Fitted with Repeating Adaptor

See page 69 for more details about the RAX repeating adaptor.

Syringe Part No.	Syringe Volume	Needle Length (mm)	Needle Gauge	Needle OD (mm)	Needle ID (mm)	Needle Tip	Syringe Code	Replacement Needle Part No.	6 Pack Part No
Fixed Needle									
002040	10 µL	50	26	0.47	0.11	Bevel	10F-RAX	-	-
Removable Needle									
001090	5 µL	50	26	0.47	0.11	Bevel	5R-RAX	036110	-
002090	10 µL	50	26	0.47	0.11	Bevel	10R-RAX	037110	-
Removable Needle - Guided Plunger									
001490	5 µL	50	26	0.47	0.11	Bevel	5R-GP-RAX	036110	-
002490	10 µL	50	26	0.47	0.11	Bevel	10R-GP-RAX	037110	-
002493	10 µL	70	26	0.47	0.11	Bevel	10R-GP-7-RAX	037130	-



SPECIFICATIONS

Accuracy and Reproducibility
±1 % (dispensed volume)

Borosilicate Glass Barrel Outer Diameter (OD)
8 mm

Scale Length
60 mm

International Standards Traceability

General Purpose Manual Syringes | 25 - 500 µL Metal Plunger



Syringe Part No.	Syringe Volume	Needle Length (mm)	Needle Gauge	Needle OD (mm)	Needle ID (mm)	Needle Tip	Syringe Code	Replacement Needle Part No.
Fixed Needle								
003000	25 µL	50	25	0.5	0.2	Bevel	25F	-
004000	50 µL	50	25	0.5	0.2	Bevel	50F	-
005000	100 µL	50	25	0.5	0.2	Bevel	100F	-
006000	250 µL	50	25	0.5	0.2	Bevel	250F	-
007000	500 µL	50	25	0.5	0.2	Bevel	500F	-
Removable Needle								
003050	25 µL	50	25	0.5	0.2	Bevel	25R	038110
004050	50 µL	50	25	0.5	0.2	Bevel	50R	038110
005050	100 µL	50	25	0.5	0.2	Bevel	100R	038110
005055	100 µL	70	25	0.5	0.2	Bevel	100R-7	038130
006050	250 µL	50	25	0.5	0.2	Bevel	250R	038110
007050	500 µL	50	25	0.5	0.2	Bevel	500R	038110

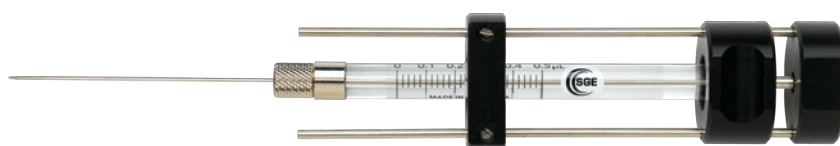

Syringes Fitted with Repeating Adaptor

See page 69 for more details about the RAX repeating adaptor.

Syringe Part No.	Syringe Volume	Needle Length (mm)	Needle Gauge	Needle OD (mm)	Needle ID (mm)	Needle Tip	Syringe Code	Replacement Needle Part No.
Removable Needle								
003090	25 µL	50	25	0.5	0.2	Bevel	25R-RAX	038110
004090	50 µL	50	25	0.5	0.2	Bevel	50R-RAX	038110
005090	100 µL	50	25	0.5	0.2	Bevel	100R-RAX	038110
006090	250 µL	50	25	0.5	0.2	Bevel	250R-RAX	038110
007090	500 µL	50	25	0.5	0.2	Bevel	500R-RAX	038110

Expert Tip:

The RAX repeating adaptor improves precision and reproducibility when repeatedly injecting the same volume manually.



SPECIFICATIONS

Accuracy and Reproducibility
±1 % (dispensed volume)

Borosilicate Glass Barrel Outer Diameter (OD)

10 µL = 6.5 mm

25 – 500 µL = 8 mm

Scale Length

10 µL = 54.1 mm

25 – 500 µL = 60 mm

International Standards Traceability

General Purpose Manual Syringes | 10 - 500 µL PTFE Tipped Plunger

Syringe Part No.	Syringe Volume	PTFE Tipped Plunger	Needle Length (mm)	Needle Gauge	Needle OD (mm)	Needle ID (mm)	Needle Tip	Syringe Code	Replacement Needle Part No.	Replacement Plunger Part No.	6 Pack Part No.
Fixed Needle											
002200	10 µL	✓	50	26	0.47	0.11	Bevel	10F-GT	-	031810	002202
002208	10 µL	✓	70	26	0.47	0.11	Bevel	10F-GT-7	-	031810	-
003200	25 µL	✓	50	25	0.50	0.20	Bevel	25F-GT	-	031815	-
004200	50 µL	✓	50	25	0.50	0.20	Bevel	50F-GT	-	031820	-
005200	100 µL	✓	50	25	0.50	0.20	Bevel	100F-GT	-	031825	-
006200	250 µL	✓	50	25	0.50	0.20	Bevel	250F-GT	-	031830	-
007200	500 µL	✓	50	25	0.50	0.20	Bevel	500F-GT	-	031835	-
Removable Needle											
002250	10 µL	✓	50	26	0.47	0.11	Bevel	10R-GT	037110	031811	002252
003250	25 µL	✓	50	25	0.50	0.20	Bevel	25R-GT	038110	031815	-
004250	50 µL	✓	50	25	0.50	0.20	Bevel	50R-GT	038110	031820	-
005250	100 µL	✓	50	25	0.50	0.20	Bevel	100R-GT	038110	031825	-
006250	250 µL	✓	50	25	0.50	0.20	Bevel	250R-GT	038110	031830	-
007250	500 µL	✓	50	25	0.50	0.20	Bevel	500R-GT	038110	031835	-
Guided Plunger											
002455	10 µL	✓	50	26	0.47	0.11	Bevel	10R-GP-GT	037110	031805	-
On-Column											
002500	10 µL	✓	75	-	0.17	0.11	On-Column	10R-GT-OC-CE	037675	031811	-
Fixed Luer Tip											
004229	50 µL	✓	-	-	-	-	-	50F-LT-GT	-	031820	-
005229	100 µL	✓	-	-	-	-	-	100F-LT-GT	-	031825	-
006229	250 µL	✓	-	-	-	-	-	250F-LT-GT	-	031830	-
007229	500 µL	✓	-	-	-	-	-	500F-LT-GT	-	031835	-
Fixed Luer Lock											
004230	50 µL	✓	-	-	-	-	-	50F-LL-GT	-	031820	-
005230	100 µL	✓	-	-	-	-	-	100F-LL-GT	-	031825	-
006230	250 µL	✓	-	-	-	-	-	250F-LL-GT	-	031830	-
007230	500 µL	✓	-	-	-	-	-	500F-LL-GT	-	031835	-



General Purpose Manual Syringes

SPECIFICATIONS

Accuracy and Reproducibility
± 1 % (dispensed volume)

Borosilicate Glass Barrel OD
1 mL = 9 mm, 2.5 mL = 11 mm, 5 mL = 14 mm,
10 mL = 18 mm, 25 mL = 27 mm, 50 mL = 32.8 mm,
100 mL = 40.8 mm

Scale Length
1 – 25 mL = 60 mm, 50 mL = 84.2 mm
100 mL = 104 mm

Thread in Plunger Stem
6-32 UNC

International Standards Traceability

General Purpose Manual Syringes | 1 - 100 mL PTFE Tipped Plunger

Also Suitable for Syringe Pumps and Dispensers

Syringe Part No.	Syringe Volume	PTFE Tipped Plunger	Needle Length (mm)	Needle Gauge	Needle OD (mm)	Needle ID (mm)	Needle Tip	Syringe Code	Replacement Needle Part No.	Replacement Plunger Part No.
Fixed Needle										
008102	1 mL	✓	50	22	0.72	0.37	Bevel	1MDF-GT	-	0318441
008502	2.5 mL	✓	50	22	0.72	0.37	Bevel	2.5MDF-GT	-	031852
Removable Needle										
008100*	1 mL	✓	50	23	0.63	0.32	Bevel	1MR-GT	039110	031842
008500	2.5 mL	✓	50	23	0.63	0.32	Bevel	2.5MDR-GT	039110	031852
008700	5 mL	✓	50	23	0.63	0.32	Bevel	5MDR-GT	031516	031856
008900	10 mL	✓	50	23	0.63	0.32	Bevel	10MDR-GT	031516	031862
Fixed Luer Tip										
008020*	1.0 mL	✓	-	-	-	-	Luer Tip	1MF-LT-GT	-	031842
008420	2.5 mL	✓	-	-	-	-	Luer Tip	2.5MDF-LT-GT	-	031852
Fixed Luer Lock										
008025	1.0 mL	✓	-	-	-	-	Luer Lock	1MDF-LL-GT	-	0318441
008425	2.5 mL	✓	-	-	-	-	Luer Lock	2.5MDF-LL-GT	-	031852
008762	5 mL	✓	-	-	-	-	Luer Lock	5MDF-LL-GT	-	0318562
008962	10 mL	✓	-	-	-	-	Luer Lock	10MDF-LL-GT	-	031864
009463	25 mL	✓	-	-	-	-	Luer Lock	25MDF-LL-GT	-	031874
Removable Luer Lock										
008760	5 mL	✓	-	-	-	-	Luer Lock	5MDR-LL-GT	-	031856
008960	10 mL	✓	-	-	-	-	Luer Lock	10MDR-LL-GT	-	031862
009462	25 mL	✓	-	-	-	-	Luer Lock	25MR-LL-GT	-	031870
009660*	50 mL	✓	-	-	-	-	Luer Lock	50MR-LL-GT	-	0312170
009760*	100 mL	✓	-	-	-	-	Luer Lock	100MR-LL-GT	-	0312176

* No thread in plunger stem of syringe part numbers 008100, 008020, 009660 and 009760.



Special Purpose Syringes

SPECIFICATIONS

Accuracy and Reproducibility
± 1 % (dispensed volume)

Borosilicate Glass Barrel Outer Diameter (OD)
See table under 'How to choose your product'.

Scale Length
60 mm

International Standards Traceability

Special Purpose Syringes | MEPS™

MEPS™ – Micro Extraction by Packed Sorbent

MEPS™ (Patent Pending) performs the same function as SPE, namely the purification or speciation of samples, but with some significant advantages:

- MEPS™ can be a fully automated one step extraction and injection process – eliminate all extra steps between sample preparation and sample injection.
- MEPS™ works with much smaller samples (as small as 3.6 µL) than full scale SPE.
- Reduce buffer and solvent volume from milliliters to microliters.
- MEPS™ is applicable to GC and LC.
- Reduce sample handling times – from hours to minutes.
- Significantly increases your sample throughput – up to 20 x faster than SPME, 40 x faster than SPE and 100 x faster than SBSE.
- Available in a variety of common SPE phases.
- Cost effective sample preparation compared to current techniques.

Sample Size

Sample volumes as small as 3.6 µL can be used or larger samples, 1 mL or more, may be concentrated by taking multiple aliquots of 100 µL or 250 µL.

Reusable

Typical Barrel-Insert-Needle (BIN) cartridge life is conservatively about 20-100 samples but actual life is dependent on the sample matrix. The small quantity of phase in the MEPS™ BIN can be easily and effectively washed between samples which removes the possibility of carry-over. This process simply is not practical on conventional SPE devices.

Flexible and Easy to Use

The MEPS™ BIN is easily installed into the syringe housing and then secured by the green front locking nut. The dimensions of the sorbent bed ensure that the sorbent performance remains identical to conventional SPE devices used for extraction of similar samples the BIN cartridge contains ~3 mg of phase.



Sample preparation for complex biological samples is readily adapted to MEPS™ and reduces the volume of sample and reagents required for extraction when compared with conventional SPE and other "micro extraction procedures".

The MEPS™ approach to sample preparation is suitable for reversed phases, normal phases, mixed mode and ion exchange chemistries. Because MEPS™ BINs can be used for sample volumes as small as 3.6 µL it makes them particularly well suited to on-line use with LC-MS analysis of volume limited samples.

How to Choose Your Product

Choose your MEPS™ syringe

The current range of syringes may be used manually or in CTC Analytics, HTA 300APlus and Varian 8400 auto-injectors. MEPS™ syringes are supplied without a needle.

Part No.	Syringe Volume (µL)	PTFE Tipped Plunger	Description	Syringe Scale Length (mm)	Syringe Barrel OD (mm)	Replacement Plunger
005291	100	✓	CTC Analytics, HTA 300APlus and Varian 8400 systems	60	6.7	031826
006291	250	✓	HTA 300APlus and Varian 8400 systems	60	6.7	031831
006292	250	✓	CTC Analytics systems	60	7.8	0318301

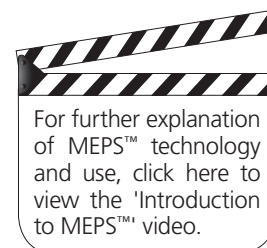

Choose your MEPS™ BINs

MEPS™ BINs are available in needle styles to suit LC and GC applications. Needles are packed in a sealed blister pack of 5 needles to ensure their integrity. MEPS™ BINs are available in a variety of common SPE phases. Individual labelling of each BIN ensures the use of the correct stationary phase for each extraction.

FOR GC APPLICATIONS (all needles are 23 gauge (0.63 mm OD), 50 mm in length and cone tipped)		
Part No.	BIN Phase	Pack Size
MEPS™ BIN for HTA 300APlus, Varian 8400 and 100 µL CTC Analytics Systems (for use with MEPS™ syringe P/N 005291 and P/N 006291)		
2900101	C18	5
2900102	Silica	5
2900103	C8+SCX	5
2900104	C2	5
2900106	C8	5
2900105	Development kit (contains 1 each of C18, C8, C2, SILICA and C8+SCX)	5
MEPS™ BIN for CTC Analytics Systems using 250 µL Syringes (for use with MEPS™ syringe P/N. 006292)		
2900301	C18	5
2900302	Silica	5
2900303	C8+SCX	5
2900304	C2	5
2900306	C8	5
2900305	Development kit (contains 1 each of C18, C8, C2, SILICA and C8+SCX)	5



FOR LC APPLICATIONS (all needles are 22 gauge (0.72 mm OD), 50 mm in length and LC tipped)		
Part No.	BIN Phase	Pack Size
MEPS™ BIN for HTA 300APlus, Varian 8400 and 100 µL CTC Analytics systems (for use with MEPS syringe part no.s 005291 and 006291)		
2900401	C18	5
2900402	Silica	5
2900403	C8+SCX	5
2900404	C2	5
2900406	C8	5
2900408	SCX	5
2900409	SAX	5
2900405	Development kit (contains 1 each of C18, C8, C2, SILICA and C8+SCX)	5
MEPS™ BIN for CTC Analytics systems using 250 µL syringes (for use with MEPS syringe part no. 006292)		
2900501	C18	5
2900502	Silica	5
2900503	C8+SCX	5
2900504	C2	5
2900506	C8	5
2900508	SCX	5
2900509	SAX	5
2900505	Development kit (contains 1 each of C18, C8, C2, SILICA and C8+SCX)	5

Special Purpose Syringes



SPECIFICATIONS

Accuracy and Reproducibility
0.5 μL = $\pm 2\%$, 5 μL and 10 μL = $\pm 1\%$ (dispensed volume)

Borosilicate Glass Barrel Outer Diameter (OD)
0.5 μL = 8 mm, 5 μL and 10 μL = 6.5 mm

Scale Length
0.5 μL = 63.5 mm, 5 μL and 10 μL = 54.1 mm

International Standards Traceability

Special Purpose Syringes | On-Column

A range of popular on-column syringes are available for general purpose applications. An extended range of instrument specific syringes is also available for most common on-column inlets.

When selecting an on-column syringe, the needle Outside Diameter (OD) must be smaller than the Inside Diameter (ID) of the capillary column it will be used with. Care must also be taken to select the correct needle length to suit the on-column injector. Wherever possible, a sheathed needle should be used for maximum needle strength and protection.

Two types of needles are offered:

- All fused silica or all stainless steel.
- Sheathed fused silica or sheathed stainless steel.

Fused silica needles are coated with polyimide and should not be operated above 360 °C.

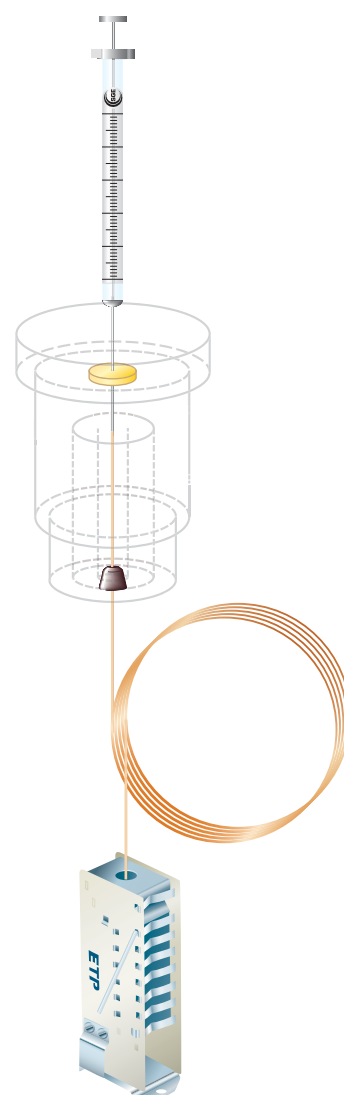

General On-Column Syringes

Syringe Part No.	Syringe Volume	Needle Length (mm)	Needle Gauge	Needle OD (mm)	Needle ID (mm)	Needle Material	Syringe Code	Replacement Needle Part No.
000372	0.5 µL	100	-	0.23	0.1	Sheathed Stainless Steel	0.5BR-OC-100S	033610*
000376	0.5 µL	70	26	0.47	0.1	Stainless Steel	0.5BR-OC-7/0.47	033630*
000380	0.5 µL	75	-	0.23	0.1	Stainless Steel	0.5BR-OC-CE-7.5	033620*
001552	5 µL	100	-	0.17	0.1	Silica	5R-OC-100VS	036610
001554	5 µL	100	-	0.17	0.1	Sheathed Silica	5R-OC-100SVS	036635
002520	10 µL	100	-	0.17	0.1	Silica	10R-OC-100VS	037610

* Plunger and needle replacement kits.

Expert Tip :

Please note the On-Column Syringes are manual syringes with needle specifications to suit specific instruments.



Special Purpose Syringes

Instrument Specific On-Column Syringes

Syringe Part No.	Syringe Volume	PTFE Tipped Plunger	Needle Length (mm)	Needle OD (mm)	Needle ID (mm)	Needle Material	Syringe Code	Replacement Needle Part No.	Replacement Plunger Part No.
Agilent Instruments									
001585	5 µL	-	50	0.19	0.11	Stainless Steel	5R-OC-5/0.19	036701	-
001587	5 µL	-	50	0.23	0.11	Stainless Steel	5R-OC-5/0.23	036703	-
Varian Instruments									
001565	5 µL	-	107	0.19	0.11	Sheathed Stainless Steel	5R-OC-VAS	036651	-
PerkinElmer Instruments									
001552	5 µL	-	100	0.17	0.1	Silica	5R-OC-100VS	036610	-
Carlo Erba									
000380	0.5 µL	-	75	0.23	0.1	Stainless Steel	0.5BR-OC-CE-7.5	033620*	-
001560	5 µL	-	75	0.23	0.11	Stainless Steel	5R-OC-CE	036675	-
001585	5 µL	-	50	0.19	0.11	Stainless Steel	5R-OC-5/0.19	036701	-
001587	5 µL	-	50	0.23	0.11	Stainless Steel	5R-OC-5/0.23	036703	-
002500	10 µL	✓	75	0.23	0.11	Stainless Steel	10R-GT-OC-CE	037675	031811
SGE (OCI-5)									
001570	5 µL	-	95	0.27	0.11	Sheathed Stainless Steel	5R-OCI5-0.27	036685	-

* Plunger and needle replacement kits.



SPECIFICATIONS

Accuracy and Reproducibility
± 2 % (dispensed volume)

Borosilicate Glass Barrel Outer Diameter (OD)
0.5 L = 70 mm, 1 L = 100 mm and 2 L = 130 mm

Scale Length
0.5 L = 179.2 mm, 1 L = 159.1 mm and 2 L = 179 mm

International Standards Traceability

Special Purpose Syringes | 0.5 L to 2 L Jumbo

- Designed for holding and dispensing large volumes of gas.
- Heavy duty acrylic barrels.
- Easy access to sample for the addition of standards or removal of subsample via secondary port.
- Plunger stem is removable for ease of transportation and storage.
- Ideal for calibration of medical equipment such as respirators and spirometers, and for stack and air sampling.
- Compatible with a range of fittings; has a 7/16" UNEF thread and designed to be used with Luer Lock needles and fittings. For the range of SGE Luer Lock needles refer to page 74.
- Refer to page 39 and 41 for the range of valves suitable for use with these syringes.



Syringe Part No.	Syringe Volume	Barrel Length (mm)	Barrel OD (mm)	Major Scale Divisions (mL)	Minor Scale Divisions (mL)	Syringe Code	Replacement Plunger O-ring Part No.
009910	0.5 L	245	70	50	25	500MAR-LL-GT	032527
009920	1 L	245	100	100	50	1000MAR-LL-GT	032532
009930	2 L	245	130	200	100	2000MAR-LL-GT	032537

Jumbo Syringe Accessories

Part No.	Description
031902	Luer Lock Adaptor
032044	Cover Nut
041822	Sealing CS Septa
030930	MSV Syringe Valve Connector
030200	I flow Two Port Standard Valve*

*Other valve configurations available, see pages 39 and 41.

SPECIFICATIONS

Accuracy and Reproducibility
 $\pm 1\%$ (dispensed volume)

Borosilicate Glass Barrel Outer Diameter (OD)
8 mm

Scale Length
5 μL = 27.05 mm and 15 μL = 36 mm

International Standards Traceability



Special Purpose Syringes | Microsyringe/Pipette

- Two different syringe volumes allow the transfer of samples from 0.2 to 15 μL .
- Only the PTFE disposable tip contacts the sample, eliminating sample cross-contamination.
- Inert, non-wetting PTFE tips are easily replaced.
- Special "bulb" needle tip for easy and firm attachment of the PTFE tips.
- The spring loaded repeating adaptor can be preset to any volume and ensures excellent reproducibility.

Syringe Part No.	Syringe Volume	Description	Replacement PTFE tubes Part No.	Replacement Needle Part No.
001496	5 μL	1 Syringe and 10 Spare PTFE Tubes	031512	036953
002996	15 μL	1 Syringe and 10 Spare PTFE Tubes	031513	037995

Replacement PTFE tubes are supplied in packets of 100. Replacement needles are supplied in packets of 2.



Special Purpose Syringes



SPECIFICATIONS

Accuracy and Reproducibility
± 1 % (dispensed volume)

Borosilicate Glass Barrel Outer Diameter (OD)
8 mm

Scale Length
60 mm

International Standards Traceability

Special Purpose Syringes | Gas Sealing Gland

- Designed to avoid cold flow deformation and leakage associated with PTFE tipped plungers used under certain conditions.
- A gas tight, high pressure PTFE seal is used at the plunger end of the syringe barrel.

Syringe Part No.	Syringe Volume	Needle Length (mm)	Needle Gauge	Needle OD (mm)	Needle ID (mm)	Needle Tip	Syringe Code	Replacement Needle Part No.
Fixed Needle								
003600	25 µL	50	25	0.5	0.2	Bevel	25F-GSG	-
004600	50 µL	50	25	0.5	0.2	Bevel	50F-GSG	-
005600	100 µL	50	25	0.5	0.2	Bevel	100F-GSG	-
006600	250 µL	50	25	0.5	0.2	Bevel	250F-GSG	-
007600	500 µL	50	25	0.5	0.2	Bevel	500F-GSG	-

Syringe Part No.	Syringe Volume	Needle Length (mm)	Needle Gauge	Needle OD (mm)	Needle ID (mm)	Needle Tip	Syringe Code	Replacement Needle Part No.
Removable Needle								
003610	25 µL	50	25	0.5	0.2	Bevel	25R-GSG	038110
004610	50 µL	50	25	0.5	0.2	Bevel	50R-GSG	038110
005610	100 µL	50	25	0.5	0.2	Bevel	100R-GSG	038110
006610	250 µL	50	25	0.5	0.2	Bevel	250R-GSG	038110
007610	500 µL	50	25	0.5	0.2	Bevel	500R-GSG	038110



SPECIFICATIONS

Accuracy and Reproducibility
± 1 % (dispensed volume)

Borosilicate Glass Barrel Outer Diameter (OD)
5 mL = 14 mm and 10 mL = 18mm

Scale Length
60 mm

International Standards Traceability



Special Purpose Syringes | Headspace/Soil Gas

Syringe Part No.	Syringe Volume	Probe Length (mm)	Needle Gauge	Probe OD (mm)	Probe ID (mm)	Needle Tip	Syringe Code	Spare Probes Pkt 1	Spare Needles Pkt 5	Replacement Plunger Part No.
008775*	5 mL	60	-	1.587	0.75	-	5MDR-HS-V	031571	039802	031857
008975*	10 mL	60	-	1.587	0.75	-	10MDR-HSV	031571	039803	031862
Replacement Probes										
031571	-	60	-	1.587	0.75	Side Hole	-	-	-	-
Replacement Needles										
039802	-	50	23	0.63	0.32	Bevel	-	-	-	-

* Syringe supplied with probe and needle.



Special Purpose Syringes



SPECIFICATIONS

Accuracy and Reproducibility
 $\pm 1\%$ (dispensed volume)

Borosilicate Glass Barrel Outer Diameter (OD)
9 mm

Scale Length
60 mm

International Standards Traceability

Special Purpose Syringes | High Pressure

- Fitted with a gas tight ON/OFF valve.
- Designed for high pressure gas sampling – rated to 500 psi/1700 kPa.

Syringe Part No.	Syringe Volume	Needle Length (mm)	Needle Gauge	Needle OD (mm)	Needle ID (mm)	Needle Tip	Syringe Code	Replacement Needle Part No.
008170	1 mL	70	23	0.63	0.37	Bevel	1M-BP	0315720
008171	1 mL	70	23	0.63	0.37	Side Hole	1M-BP (0.36)H	0315722



Syringe Valves



Syringe Valves

Syringe valves are ideal for sample storage and transportation or to pressurize sample prior to injection.

SGE offers two basic types of manually operated syringe valves; push-pull for smaller volumes (25 μ L – 2.5 mL) and push-button for larger volumes (5 mL - 2 L).

SGE Luer Tip, Luer Lock and removable needle syringes can be fitted with valves. The valve allows fluid to be stored in the syringe without contamination.



Expert Tip :

With the valve in closed position it is possible to move the plunger to pre-pressurize the sample.



Valve Part No.	Description	Syringe Volume	Valve Code	Replacement Needle Part No.
031905*	Push-pull Valve with Replaceable Needle	25 μ L - 2.5 mL	V25/2.5M-0.63C	038810
031906^	Push-pull Valve with Replaceable Needle	25 μ L - 2.5 mL	V25/2.5M-0.47C	038820
031907	Push-pull Valve with Luer Lock	25 μ L - 2.5 mL	VLL25/2.5M	-
031910	Push-button Valve with Luer Lock or Removable Needle	5 mL - 2 L	VLLMA	-
031911	Septum Valve	5 mL - 2 L	VLLMA5/2000	-
031915	Push-button Valve with Luer Lock	50 μ L - 2 L	SLLV	-

* 50 mm, 0.63 mm OD cone tip needle. ^ 50 mm, 0.47 mm OD cone tip needle.



Syringes Pre-fitted with Syringe Valves

Syringe Part No.	Syringe Volume	PTFE Tipped Plunger	Syringe Code	Replacement Needle Part No.	Replacement Plunger Part No.	Replacement Valve Part No.
Pre-fitted with Removable Needle and Valve						
004279	50 µL	✓	50R-V-GT	038810	031820	031905
005279	100 µL	✓	100R-V-GT	038810	031825	031905
006279	250 µL	✓	250R-V-GT	038810	031830	031905
007279	500 µL	✓	500R-V-GT	038810	031835	031905
008110	1 mL	✓	1MR-V-GT	038810	031842	031905
008510	2.5 mL	✓	2.5MDR-V-GT	038810	031852	031905
Pre-fitted with Luer Lock Valve						
008160	1 mL	✓	1MR-VLL-GT	-	031842	031907
008560	2.5 mL	✓	2.5MDR-VLL-GT	-	031852	031907
008770	5 mL	✓	5MDR-VLLMA-GT	-	031856	031910
008970	10 mL	✓	10MDR-VLLMA-GT	-	031862	031910
009472	25 mL	✓	25MDR-VLLMA-GT	-	031870	031910
009670	50 mL	✓	50MR-VLLMA-GT	-	0312170	031910
009770	100 mL	✓	100MR-VLLMA-GT	-	0312176	031910

Syringe Valves

Valve Needles

Valve Needle Part No.	Needle Length (mm)	Needle Gauge	Needle OD (mm)	Needle ID (mm)	Needle Tip	Pack Size
For use with P/N 031905 and 031906						
038810	50	23	0.63	0.20	Cone	1
038815	50	23	0.63	0.20	Side Hole/Dome	1
038820	50	26	0.47	0.24	Cone	1

See page 74 for the complete range of Luer Lock needles suitable for use on Luer Lock valves.



SPECIFICATIONS

Flow Path: 1.5 mm (0.059")

Threaded Ports: 1/4-28 UNF

Pressure Rating: 120 psi

Temperature Rating: 10-120 °C

Standard Weight: 58 g

Bulkhead Weight: 65 g

Breakaway Torque: 0.15 Nm

Lifetime Testing: ≥ 8,000 cycles



Syringe Valves | SealTight™

SealTight™ low pressure valves are designed for improved valve seal life. SGE valves have overcome the problem of leakage by reducing perpendicular rotor force, and optimizing the rotor face union, thereby improving PTFE plug integrity. The end result is a longer life seal. The SealTight™ Valves are completely inert and enable connection of a variety of fittings. Valves are available in standard (SV) or bulkhead panel mounting connection (SVP) which can be easily mounted to a dispenser. Other valves, including custom OEM configurations, are available.

ADVANTAGES

- Extended life resulting from new face rotor seal technology, making valves cost effective and reliable.
- Inert PTFE and Kel-F® flow path compatible with a variety of solvents and sample matrices.
- Easily reassembled by hand: no need to torque it up like other valves.
- Screw thread connection directly onto 5 mL - 2 L syringes using valve connector (Part No. 030930) for convenience.

APPLICATIONS

SealTight™ valves offer the versatility to be utilized in a variety of industries. They can be added to the following systems:

- Dispensers.
- Diluters.
- Flow path variation.
- Biocompatible, suitable for use in pathology equipment.

Part No.	Description	Mounting	Code
Distribution Valves			
030025	2-way L	Bulkhead	SVP-2L/D
030040	3-way T	Standard	SV-3T/D
030045	3-way T	Bulkhead	SVP-3T/D
Port Valves			
030200	I flow 2 port	Standard	SV-2I/I
030240	T flow 3 port	Standard	SV-3T/T
030245	T flow 3 port	Bulkhead	SVP-3T/T
030260	L flow 3 port	Standard	SV-3T/L
030265	L flow 3 port	Bulkhead	SVP-3T/L



2-way L



3-way T



I flow 2 port



T flow 3 port



L flow 3 port

SealTight™ Valve Fittings and Connectors

Part No.	Description	Code
030900	Kel-F Female Luer	KSV-FL
030905	Kel-F Male Luer	KSV-LT
030920	Metal Thread Male Luer Lock - PTFE Flow Path	MSV-LL
030930	Syringe - Valve Connector (fits 5 mL - 2 L syringes) PTFE Flow Path	MSV-SYR
030950	Flangeless Tubing Connector for 1/16" Tubing (includes 2 ferrules)	MSV-1/16
030952	Flangeless Tubing Connector for 1/8" Tubing (includes 2 ferrules)	MSV-1/8FLT
0730018	Replacement Ferrules for 1/16" Tubing	PF16-16
0730019	Replacement Ferrules for 1/8" Tubing	PF8-8

GC Autosampler Syringes

SPECIFICATIONS

Accuracy and Reproducibility
 $\pm 1\%$ (dispensed volume)
 $(\pm 2\%$ for 0.5 μL and 1 μL syringes)

Borosilicate Glass Barrel Outer Diameter (OD)
 0.5 μL = 6.5 mm , 1 μL = 8 mm (except P/N 000610 which is 6.5 mm)
 5 μL to 250 μL = 6.5 mm

Scale Length
 54.1 mm (except P/N 000610 which is 27.05 mm)

International Standards Traceability

GC Autosampler Syringes | Agilent Instruments

Syringe Part No.	Syringe Volume	PTFE Tipped Plunger	Needle Length (mm)	Needle Gauge	Needle OD (mm)	Needle ID (mm)	Needle Tip	Syringe Code	Replacement Needle Part No.	Replacement Plunger Part No.	6 Pack Part No.	10 Pack Part No.	25 Pack Part No.
HP7673, 7683, 7693A and 6850ALS Fixed Needle													
001800	5 μL	-	42	26	0.47	0.11	Cone	5F-HP-0.47	-	-	001804	-	-
001810	5 μL	-	42	23	0.63	0.11	Cone	5F-HP-0.63	-	-	001814	-	-
001821	5 μL	-	42	23-26	0.63/0.47	0.11	Cone	5F-HP-0.63/0.47	-	-	001822	-	-
002800	10 μL	-	42	26	0.47	0.11	Cone	10F-HP-0.47	-	-	002804	-	-
002810	10 μL	-	42	23	0.63	0.11	Cone	10F-HP-0.63	-	-	002814	-	002813
002812	10 μL	✓	42	23	0.63	0.11	Cone	10F-HP-GT-0.63	-	031808	-	-	-
002821	10 μL	-	42	23-26	0.63/0.47	0.11	Cone	10F-HP-0.63/0.47	-	-	002822	-	002824
002826	10 μL	✓	42	23-26	0.63/0.47	0.11	Cone	10F-HP-GT-63/47	-	031808	002827	-	-
002839	10 μL	-	42	23	0.63	0.11	Cone	10F-4.2/0.63C	-	-	-	-	-
003668	25 μL	✓	42	23-26	0.63/0.47	0.11	Cone	25F-HP-GT-0.63/47	-	031818	-	-	-
004668	50 μL	✓	42	23-26	0.63/0.47	0.11	Cone	50F-HP-GT-0.63/47	-	031822	-	-	-
005668	100 μL	✓	42	23-26	0.63/0.47	0.11	Cone	100F-HP-GT-63/47	-	031823	-	-	-
HP7673, 7683, 7693A and 6850ALS Fixed Needle - SuperFlex™ Flexible Plunger													
002830	10 μL	-	42	26	0.47	0.11	Cone	10FX-HP-0.47	-	-	002831	-	-
002835	10 μL	-	42	23	0.63	0.11	Cone	10FX-HP-0.63	-	-	002838	-	-



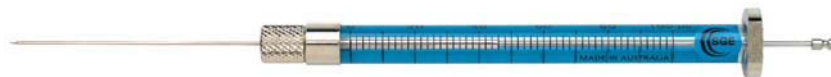

Syringe Part No.	Syringe Volume	PTFE Tipped Plunger	Needle Length (mm)	Needle Gauge	Needle OD (mm)	Needle ID (mm)	Needle Tip	Syringe Code	Replacement Needle Part No.	Replacement Plunger Part No.	6 Pack Part No.	10 Pack Part No.	25 Pack Part No.
HP7673, 7683, 7693A and 6850ALS Removable Needle													
000400	0.5 µL	-	42	26	0.47	0.1	Cone	0.5BR-HP-0.47	033708	-	-	-	-
000410	0.5 µL	-	42	23	0.63	0.1	Cone	0.5BR-HP-0.63	033715	-	-	-	-
000415	0.5 µL	-	42	23-26	0.63/0.47	0.1	Cone	0.5BR-HP-63/47	033730	-	-	-	-
000610	1 µL	-	42	23	0.63	0.22	Cone	1BR-HP-0.63	034715	-	-	-	-
001805	5 µL	-	42	26	0.47	0.11	Cone	5R-HP-0.47	036710	-	-	-	-
001815	5 µL	-	42	23	0.63	0.11	Cone	5R-HP-0.63	036720	-	-	-	-
001825	5 µL	-	42	23-26	0.63/0.47	0.11	Cone	5R-HP-0.63/0.47	036730	-	-	-	-
002805	10 µL	-	42	26	0.47	0.11	Cone	10R-HP-0.47	037715	-	-	-	-
002815	10 µL	-	42	23	0.63	0.11	Cone	10R-HP-0.63	037717	-	-	-	-
002817	10 µL	✓	42	26	0.47	0.11	Cone	10R-HP-GT-0.47	037715	031809	-	-	-
002818	10 µL	✓	42	23	0.63	0.11	Cone	10R-HP-GT-0.63	037717	031809	-	002820	-
002825	10 µL	-	42	23-26	0.63/0.47	0.11	Cone	10R-HP-0.63/0.47	037730	-	-	-	-
002829	10 µL	✓	42	23-26	0.63/0.47	0.11	Cone	10R-HP-GT-63/47	037730	031809	-	-	-
003665	25 µL	-	42	23	0.63	0.2	Cone	25R-HP-0.63	038717	-	-	-	-
004665	50 µL	-	42	23	0.63	0.24	Cone	50R-HP-0.63	038717	-	-	-	-
005665	100 µL	-	42	23	0.63	0.24	Cone	100R-HP-0.63	038717	-	-	-	-
006665	250 µL	-	42	23	0.63	0.24	Cone	250R-HP-0.63	038717	-	-	-	-
HP7673, 7683, 7693A and 6850ALS Removable Needle Syringes - SuperFlex™ Flexible Plunger													
002844	10 µL	-	42	26	0.47	0.11	Cone	10RX-HP-0.47	037715	-	-	-	-
002845	10 µL	-	42	23	0.63	0.11	Cone	10RX-HP-0.63	037717	-	-	-	-
HP7670 Removable Needle													
000585	1 µL	-	50	23	0.63	0.15	Bevel	1BR-F5	034705	-	-	-	-
HP7671A-7672 Removable Needle													
000587	1 µL	-	56	23	0.63	0.15	Bevel	1BR-FV-56	034710	-	-	-	-

GC Autosampler Syringes



Specifications of the following syringes are matched to CTC holders to ensure proper fit and reliable functioning.

SPECIFICATIONS

Accuracy and Reproducibility
 $\pm 1\%$ (dispensed volume)
 $(\pm 2\%$ for 0.5 μL and 1 μL syringes)

Borosilicate Glass Barrel Outer Diameter (OD)
 0.5 μL to 100 μL = 6.5 mm, 250 μL and 500 μL = 8 mm, 1 mL = 7.6 mm, 2.5 mL = 9.7 mm

Scale Length
 0.5 μL = 27.05 mm, 5 μL and 10 μL = 54.1 mm, 25 μL to 2.5 mL = 60 mm

International Standards Traceability

GC Autosampler Syringes | CTC Analytics

Syringe Part No.	Syringe Volume	PTFE Tipped Plunger	Needle Length (mm)	Needle Gauge	Needle OD (mm)	Needle ID (mm)	Needle Tip	Syringe Code	Replacement Plunger Part No.	6 Pack Part No.
Fixed Needle										
001700	5 μL	-	50	26	0.47	0.1	Cone	5F-CTC-5/0.47C	-	-
001981	5 μL	-	50	23	0.63	0.11	Cone	5F-C/T-5/0.63C	-	-
001982	5 μL	-	50	26	0.47	0.11	Cone	5F-C/T-5/0.47C	-	-
002977	10 μL	✓	50	26	0.47	0.11	Cone	10F-C/T-GT-5/0.47C	031803	002976
002700	10 μL	-	50	26	0.47	0.15	Cone	10F-CTC-5/0.47C	-	-
002705	10 μL	-	50	26	0.47	0.11	Bevel	10F-CTC-5/0.47BV	-	-
002981	10 μL	-	50	23	0.63	0.11	Cone	10F-C/T-5/0.63C	-	002971
002983	10 μL	-	50	22	0.72	0.175	Side Hole	10F-CTC-GT-5/0.72H	-	-
002987	10 μL	✓	50	23	0.63	0.11	Cone	10F-C/T-GT-5/0.63C	031803	002972
003700	25 μL	✓	50	26	0.47	0.11	Cone	25F-CTC-GT-5/0.47C	0318922	-
003980	25 μL	-	50	26	0.47	0.15	Cone	25F-C/T-0.47C	-	-
003987	25 μL	✓	50	23	0.63	0.24	Cone	25F-C/T-GT-0.63C	031817	-
005700	100 μL	✓	50	26	0.47	0.11	Cone	100F-CTC-GT-5/0.47C	031826	-
005335	100 μL	✓	50	23	0.63	0.24	Cone	100F-C/T-GT-0.63C	031826	-
006700	250 μL	✓	50	26	0.47	0.25	Cone	250F-CTC-GT-5/0.47C	0318926	-
007700	500 μL	✓	50	26	0.47	0.25	Cone	500F-CTC-GT-5/0.47C	0318928	-
008135	1 mL	✓	56	26	0.47	0.15	Side Hole	1MF-CTC-GT-HS-5/0.47H	0318441	-
008130	1 mL	✓	56	23	0.63	0.15	Side Hole	1MF-CTC-GT-HS-5/0.63H	0318441	-
008635	2.5 mL	✓	56	26	0.47	0.15	Side Hole	2.5MF-CTC-GT-HS-5/0.47H	0318451	-
008630	2.5 mL	✓	56	23	0.63	0.15	Side Hole	2.5MF-CTC-GT-HS-5/0.63H	0318451	-





Syringe Part No.	Syringe Volume	PTFE Tipped Plunger	Needle Length (mm)	Needle Gauge	Needle OD (mm)	Needle ID (mm)	Needle Tip	Syringe Code	Replacement Needle Part No.	Replacement Plunger Part No.
Removable Needle										
000490	0.5 µL	-	50	26	0.47	0.175	Cone	0.5BNR-C/T-0.47C	033770	-
000492	0.5 µL	-	50	23	0.63	0.15	Cone	0.5BNR-C/T-0.63C	033772	-
001984	5 µL	-	50	23	0.63	0.11	Cone	5R-C/T-0.63C	036011	-
002965	10 µL	✓	51.5	23	0.63	0.11	Cone	10R-C/T-GT-5.15/0.63C	037013	0318121
002982	10 µL	-	50	26	0.47	0.11	Cone	10R-C/T-5/0.47C	037785	-
002984	10 µL	-	50	23	0.63	0.11	Cone	10R-C/T-0.63C	037787	-
002985	10 µL	✓	50	26	0.47	0.11	Cone	10R-C/T-GT-0.47C	037787	0318121
003988	25 µL	✓	50	26	0.47	0.24	Side Hole	25R-C/T-GT-0.47H	038749	031816
003989	25 µL	✓	50	22	0.72	0.375	Side Hole	25R-C/T-GT 0.72H	038420	031816
005333	100 µL	✓	50	26	0.47	0.2	Cone	100R-C/T-GT-0.47C	038732	031826
005337	100 µL	✓	50	23	0.63	0.24	Side Hole	100R-C/T-GT-0.63H	038736	031826

GC Autosampler Syringes

SPECIFICATIONS

Accuracy and Reproducibility
 $\pm 1\%$ (dispensed volume)
 $(\pm 2\%$ for 0.5 μL and 1 μL syringes)

Borosilicate Glass Barrel Outer Diameter (OD)
 6.5 mm

Scale Length
 0.5 μL and 5 μL = 27 mm, 50 μL = 54.1 mm

International Standards Traceability

GC Autosampler Syringes | PerkinElmer Instruments

Syringe Part No.	Syringe Volume	PTFE Tipped Plunger	Needle Length (mm)	Needle Gauge	Needle OD (mm)	Needle ID (mm)	Needle Tip	Syringe Code	Replacement Needle Part No.	Replacement Plunger Part No.
AutoSystem and Clarus 500 Fixed Needle										
001953	5 μL	-	70	26	0.47	0.15	Cone	5F-PE-0.47	-	-
001954	5 μL	-	70	23	0.63	0.15	Cone	5F-PE-0.63	-	-
001955	5 μL	✓	70	26	0.47	0.15	Cone	5F-PE-GT-0.47	-	031807
001957	5 μL	✓	70	23	0.63	0.15	Cone	5F-PE-GT-0.63	-	031807
004670	50 μL	-	70	23	0.63	0.24	Cone	50F-PE-0.63	-	-



Syringe Part No.	Syringe Volume	PTFE Tipped Plunger	Needle Length (mm)	Needle Gauge	Needle OD (mm)	Needle ID (mm)	Needle Tip	Syringe Code	Replacement Needle and Plunger Kit Part No.
AutoSystem and Clarus 500 Removable Needle									
000475	0.5 μL	-	70	26	0.47	0.1	Beveled Cone	0.5BR-PE-0.47	033750
000478	0.5 μL	-	70	23	0.63	0.1	Cone	0.5BR-PE-0.63	033765

SPECIFICATIONS

Accuracy and Reproducibility
 $\pm 1\%$ (dispensed volume)
 $(\pm 2\%$ for 0.5 μL and 1 μL syringes)

Borosilicate Glass Barrel Outer Diameter (OD)
 6.5 mm

Scale Length
 0.5 μL = 27.05 mm, 5 μL to 250 μL = 54.1 mm

International Standards Traceability



GC Autosampler Syringes | Shimadzu Instruments

Syringe Part No.	Syringe Volume	PTFE Tipped Plunger	Needle Length (mm)	Needle Gauge	Needle OD (mm)	Needle ID (mm)	Needle Tip	Syringe Code	Replacement Needle Part No.	Replacement Plunger Part No.
AOC 9 Removable Needle										
000435	0.5 μL	-	50	26	0.47	0.1	Cone	0.5BR-S(9)0.47	033732	-
002885	10 μL	-	50	26	0.47	0.11	Cone	10R-S(9)-0.47	037736	-

Syringe Part No.	Syringe Volume	PTFE Tipped Plunger	Needle Length (mm)	Needle Gauge	Needle OD (mm)	Needle ID (mm)	Needle Tip	Syringe Code	Replacement Needle Part No.	Replacement Plunger Part No.
AOC 14, 17, 20 and 20i Fixed Needle										
001987	5 μL	-	42	26	0.47	0.11	Cone	5F-S-0.47	-	-
001988	5 μL	-	42	23	0.63	0.11	Cone	5F-S-0.63	-	-
004682	50 μL	-	42	23	0.63	0.24	Cone	50F-S-0.63	-	-
006682	250 μL	✓	42	23	0.63	0.24	Cone	250F-S-GT-0.63	-	031828



Syringe Part No.	Syringe Volume	PTFE Tipped Plunger	Needle Length (mm)	Needle Gauge	Needle OD (mm)	Needle ID (mm)	Needle Tip	Syringe Code	Replacement Needle Part No.	Replacement Plunger Part No.
AOC 14, 17, 20 and 20i Removable Needle										
000440	0.5 μL	-	42	26	0.47	0.1	Cone	0.5BR-S-0.47	033738	-
000445	0.5 μL	-	42	23	0.63	0.1	Cone	0.5BR-S-0.63	033745	-
002897	10 μL	-	42	26	0.47	0.11	Cone	10R-S-0.47	037745	-
002898	10 μL	-	42	23	0.63	0.11	Cone	10R-S-0.63	037747	-
002902	10 μL	✓	42	23	0.63	0.11	Cone	10R-S-GT-0.63	037747	031798

For syringes to suit the Shimadzu AOC-5000 Autosampler refer to the CTC Autosampler syringes on page 45.

GC Autosampler Syringes



SPECIFICATIONS

Accuracy and Reproducibility
 $\pm 1\%$ (dispensed volume)
 $(\pm 2\%$ for 0.5 μL and 1 μL syringes)

Borosilicate Glass Barrel Outer Diameter (OD)
 6.5 mm

Scale Length
 0.5 μL = 27.05 mm, 10 μL = 54.1 mm

International Standards Traceability

GC Autosampler Syringes | Thermo Scientific Instruments

Syringe Part No.	Syringe Volume	PTFE Tipped Plunger	Needle Length (mm)	Needle Gauge	Needle OD (mm)	Needle ID (mm)	Needle Tip	Syringe Code	Replacement Needle Part No.	Replacement Plunger Part No.	Model				6 Pack Part No.
											TriPlus	AS3000	AS2000	AS200/800	
Fixed Needle															
001981	5 μL	-	50	23	0.63	0.11	Cone	5F-C/T-5/0.63C	-	-	✓	-	-	-	-
002989	10 μL	-	80	23	0.63	0.11	Cone	10F-C/T-8/0.63C	-	-	✓	-	✓	-	-
002992	10 μL	-	80	26	0.47	0.11	Cone	10F-C/T-8/0.47C	-	-	✓	-	✓	-	-
002967	10 μL	-	50	25	0.50	0.125	Cone	10F-C/T-5/0.50C	-	-	✓	✓	✓	✓	-
002974	10 μL	-	80	22	0.72	0.175	Cone	10F-C/T-8/22C	-	-	✓	-	✓	-	-
002987	10 μL	✓	50	23	0.63	0.11	Cone	10F-C/T-GT-5/0.63C	-	031803	✓	-	✓	-	002972
002981	10 μL	-	50	23	0.63	0.11	Cone	10F-C/T-5/0.63C	-	-	✓	✓	✓	✓	002971
002980	10 μL	-	50	26	0.47	0.11	Cone	10F-C/T-5/0.47C	-	-	✓	✓	✓	✓	002986



Syringe Part No.	Syringe Volume	PTFE Tipped Plunger	Needle Length (mm)	Needle Gauge	Needle OD (mm)	Needle ID (mm)	Needle Tip	Syringe Code	Replacement Needle Part No.	Replacement Plunger Part No.	Model				6 Pack Part No.
											TriPlus	AS3000	AS2000	AS200/800	
Removable Needle															
000490	0.5 μL	-	50	26	0.47	0.155	Cone	0.5BNR-C/T-5/0.47C	033770	-	✓	✓	-	-	-
000492	0.5 μL	-	50	23	0.63	0.155	Cone	0.5BNR-C/T-5/0.63C	033772	-	✓	✓	-	-	-
002982	10 μL	-	50	26	0.47	0.11	Cone	10R-C/T-5/0.47C	037785	-	✓	✓	✓	-	-
002984	10 μL	-	50	23	0.63	0.11	Cone	10R-C/T-5/0.63C	037787	-	✓	✓	✓	✓	-
002993	10 μL	-	80	26	0.47	0.15	Cone	10R-C/T-8/0.47C	031535	-	✓	-	✓	-	-



SPECIFICATIONS

Accuracy and Reproducibility
 $\pm 1\%$ (dispensed volume)
 $(\pm 2\%$ for 0.5 μL and 1 μL syringes)

Borosilicate Glass Barrel Outer Diameter (OD)
 8 mm

Scale Length
 54.1 mm

International Standards Traceability



GC Autosampler Syringes | Unicam Instruments

Syringe Part No.	Syringe Volume	PTFE Tipped Plunger	Needle Length (mm)	Needle Gauge	Needle OD (mm)	Needle ID (mm)	Needle Tip	Syringe Code	Replacement Needle Part No.
Removable Needle									
000581	1 μL	-	70	26	0.47	0.15	Cone	1BR-U-7/0.47C	034772*
000582	1 μL	-	70	23	0.63	0.15	Bevel	1BR-U-7BV	034770*
002684	10 μL	-	70	22	0.7	0.15	S/Bevel	10R-U-7T	037330

* These are needle and plunger kits

GC Autosampler Syringes



Syringe Brilliance

SPECIFICATIONS

Accuracy and Reproducibility
 $\pm 1\%$ (dispensed volume)
 $(\pm 2\%$ for 0.5 μL and 1 μL syringes)

Borosilicate Glass Barrel Outer Diameter (OD)
 1 μL = 8 mm, 10 μL = 6.5 mm, 100 μL = 8 mm

Scale Length
 1 μL and 10 μL = 54.1 mm, 100 μL = 60 mm

International Standards Traceability

GC Autosampler Syringes | Varian Instruments

Syringe Part No.	Syringe Volume	PTFE Tipped Plunger	Needle Length (mm)	Needle Gauge	Needle OD (mm)	Needle ID (mm)	Needle Tip	Syringe Code	Replacement Needle Part No.	Replacement Plunger Part No.
8035, 8100 and 8200 Series Fixed Needle										
002923	10 μL	✓	53	25	0.5	0.15	S/Hole	10F-GT-VA8X-2	-	031218
8400/8410, CP-9010/9050 Series Fixed Needle										
002950	10 μL	-	50	26	0.47	0.11	Bevel	10F-VA8400-5/0.47	-	-
002981	10 μL	-	50	23	0.63	0.11	Cone	10F-C/T-5/0.63C	-	-



Syringe Part No.	Syringe Volume	PTFE Tipped Plunger	Needle Length (mm)	Needle Gauge	Needle OD (mm)	Needle ID (mm)	Needle Tip	Syringe Code	Replacement Needle Part No.	Replacement Plunger Part No.
8000 Series Removable Needle										
002926	10 μL	✓	50	25	0.5	0.15	Dome	10R-GT-VA80-2	037775	031218
8035, 8100 and 8200 Series Removable Needle										
000655	1 μL	-	51	26	0.47	0.15	Cone	1BR-VA8X	034720*	-
002924	10 μL	✓	53	25	0.5	0.15	S/Hole	10R-GT-VA8X-2	037777	031218
005921	100 μL	✓	53	25	0.5	0.2	S/Hole	100R-GT-VA8X	038745	031824
8400/8410, CP-9010/9050 Series Removable Needle										
002982	10 μL	-	50	26	0.47	0.11	Cone	10R-C/T-5/0.47C	037785	-

* This is a needle and plunger kit



LC Manual Syringes

SPECIFICATIONS

Accuracy and Reproducibility
± 1 % (dispensed volume)

Borosilicate Glass Barrel Outer Diameter (OD)
5 µL and 10 µL = 6.5 mm, 25 µL to 500 µL = 8 mm,
1 mL = 8.8 mm, 2.5 mL = 10.8 mm

Scale Length
60 mm

International Standards Traceability

LC Manual Syringes | Beckman/Altex, Rheodyne, SSI Instruments and Valco Valves

Syringe Part No.	Syringe Volume	PTFE Tipped Plunger	Needle Length (mm)	Needle Gauge	Needle OD (mm)	Needle ID (mm)	Needle Tip	Syringe Code	Replacement Plunger Part No.	6 Pack Part No.
Fixed Needle										
001301	5 µL	-	51	22	0.028"	0.17	LC	5F-LC	-	-
002300	10 µL SuperfleX™	-	51	22	0.028"	0.17	LC	10FX-LC	-	002330
002301	10 µL	-	51	22	0.028"	0.17	LC	10F-LC	-	002315
002335	10 µL	✓	51	23	0.028"	0.17	LC	10F-LC-GT	031810	-
003300	25 µL	-	51	22	0.028"	0.37	LC	25F-LC	-	-
004300	50 µL	-	51	22	0.028"	0.37	LC	50F-LC	-	-
005300	100 µL	-	51	22	0.028"	0.37	LC	100F-LC	-	-
006300	250 µL	-	51	22	0.028"	0.37	LC	250F-LC	-	-
007300	500 µL	-	51	22	0.028"	0.37	LC	500F-LC	-	-



Syringe Part No.	Syringe Volume	PTFE Tipped Plunger	Needle Length (mm)	Needle Gauge	Needle OD (mm)	Needle ID (mm)	Needle Tip	Syringe Code	Replacement Needle Part No.
Removable Needle with Repeating Adaptor									
002345	10 µL	-	51	22	0.028"	0.17	LC	10R-LC-RAX	037250
003320	25 µL	-	51	22	0.028"	0.37	LC	25R-LC-RAX	038251
004320	50 µL	-	51	22	0.028"	0.37	LC	50R-LC-RAX	038254
005320	100 µL	-	51	22	0.028"	0.37	LC	100R-LC-RAX	038257
006320	250 µL	-	51	22	0.028"	0.37	LC	250R-LC-RAX	038260
007320	500 µL	-	51	22	0.028"	0.37	LC	500R-LC-RAX	038263





Syringe Part No.	Syringe Volume	PTFE Tipped Plunger	Needle Length (mm)	Needle Gauge	Needle OD (mm)	Needle ID (mm)	Needle Tip	Syringe Code	Replacement Needle Part No.	Replacement Plunger Part No.
Removable Needle										
001310	5 µL	-	51	22	0.028"	0.17	LC	5R-LC	036250	-
002310	10 µL	-	51	22	0.028"	0.17	LC	10R-LC	037250	-
002313	10 µL	✓	51	22	0.028"	0.17	LC	10R-GT-LC	037250	031811
002350	10 µL	-	51	22	0.028"	0.17	LC	10RX-LC	037250	-
003310	25 µL	-	51	22	0.028"	0.37	LC	25R-LC	038250	-
003312	25 µL	✓	51	22	0.028"	0.37	LC	25R-GT-LC	038250	031815
004310	50 µL	-	51	22	0.028"	0.37	LC	50R-LC	038252	-
004312	50 µL	✓	51	22	0.028"	0.37	LC	50R-GT-LC	038253	031820
005310	100 µL	-	51	22	0.028"	0.37	LC	100R-LC	038255	-
005312	100 µL	✓	51	22	0.028"	0.37	LC	100R-GT-LC	038256	031825
006310	250 µL	-	51	22	0.028"	0.37	LC	250R-LC	038258	-
006312	250 µL	✓	51	22	0.028"	0.37	LC	250R-GT-LC	038259	031830
007310	500 µL	-	51	22	0.028"	0.37	LC	500R-LC	038261	-
007312	500 µL	✓	51	22	0.028"	0.37	LC	500R-GT-LC	038262	031835
008105	1 mL	✓	51	22	0.028"	0.37	LC	1MR-LC-GT	039250	031842
008505	2.5 mL	✓	51	22	0.028"	0.37	LC	2.5MDR-LC-GT	039250	031852

Expert Tip :
Users of Valco injectors requiring 3/4" long needles, must fit a Valco VISF-2 adaptor.



Expert Tip:

When using the complete loop fill technique, the syringe capacity should be greater than twice the loop volume. The loop capacity sets the injection volume.

When using the partial loop technique, the injection volume should be no greater than half the loop capacity. The injection size sets the injection volume.



LC Manual Syringes



SPECIFICATIONS

Accuracy and Reproducibility
± 1 % (dispensed volume)

Borosilicate Glass Barrel Outer Diameter (OD)
8 mm

Scale Length
60 mm

International Standards Traceability

LC Manual Syringes | Waters U6K Valves

Syringe Part No.	Syringe Volume	PTFE Tipped Plunger	Needle Length (mm)	Needle Gauge	Needle OD (mm)	Needle ID (mm)	Needle Tip	Syringe Code	Replacement Needle Part No.
Removable Needle									
003375	25 µL	-	50	25	0.5	0.2	LC	25R-WLC-RAX	038260
004375	50 µL	-	50	25	0.5	0.2	LC	50R-WLC-RAX	038260
005375	100 µL	-	50	25	0.5	0.2	LC	100R-WLC-RAX	038260
006375	250 µL	-	50	25	0.5	0.2	LC	250R-WLC-RAX	038260
007375	500 µL	-	50	25	0.5	0.2	LC	500R-WLC-RAX	038260



Expert Tip:

The RAX repeating adaptor improves precision and reproducibility when repeatedly injecting the same volume manually.



LC Autosampler Syringes

SPECIFICATIONS

Accuracy and Reproducibility
± 1 % (dispensed volume)

Borosilicate Glass Barrel Outer Diameter (OD)
8 mm

Scale Length
60 mm

International Standards Traceability

LC Autosampler Syringes | Agilent Instruments

Syringe Part No.	Syringe Volume	PTFE Tipped Plunger	Termination	Syringe Code	Replacement Plunger Part No.
003670	25 µL	✓	1/4-28 UNEF	25D-HP1090-GT	0318181
006670	250 µL	✓	1/4-28 UNEF	250D-HP1090-GT	031829

SPECIFICATIONS

Accuracy and Reproducibility
± 1 % (dispensed volume)

Borosilicate Glass Barrel Outer Diameter (OD)
8 mm

Scale Length
No scale

International Standards Traceability

LC Autosampler Syringes | Hitachi Instruments

Syringe Part No.	Syringe Volume	PTFE Tipped Plunger	Front Thread	Syringe Code	Replacement Plunger Part No.
007660	500 µL	✓	M10 x 1.0	500C-HITACHI	031837

SPECIFICATIONS

Accuracy and Reproducibility
± 1 % (dispensed volume)

Borosilicate Glass Barrel Outer Diameter (OD)

10 µL to 250 µL = 6.5mm (except P/N 003715 and P/N 006720 = 8 mm)
500 µL = 8 mm, 1 mL = 7.6 mm, 2.5 mL = 9.7 mm, 5 mL = 14 mm

Scale Length

10 µL = 54.1 mm, 25 µL to 5 mL = 60 mm

International Standards Traceability



LC Autosampler Syringes | CTC Analytics/Leap

Syringe Part No.	Syringe Volume	PTFE Tipped Plunger	Needle Length (mm)	Needle Gauge	Needle OD (mm)	Needle ID (mm)	Needle Tip	Syringe Code	Replacement Needle Part No.	Replacement Plunger Part No.
Fixed Needle										
002710	10 µL	-	51	22	0.72	0.17	LC	10F-CTC-LC	-	-
002715	10 µL	✓	51	22	0.72	0.17	LC	10F-CTC-GT-LC	-	031803
003715*	25 µL	✓	51	22	0.72	0.17	LC	25F-CTC-GT-LC	-	0318921
003984	25 µL	-	51	22	0.72	0.37	LC	25F-C/F-LC	-	-
004810	50 µL	✓	51	22	0.72	0.37	LC	50F-C/T-GT-LC	-	031821
005715	100 µL	✓	51	22	0.72	0.17	LC	100F-CTC-GT-LC	-	0318261
005720	100 µL	✓	51	22	0.72	0.4	LC	100F-CTC-GT-LC (0.4)	-	0318924
006720*	250 µL	✓	51	22	0.72	0.4	LC	250F-CTC-GT-LC (0.4)	-	0318926
007720	500 µL	✓	51	22	0.72	0.4	LC	500F-CTC-GT-LC (0.4)	-	0318928

* Please note barrel OD is 8mm.



Syringe Part No.	Syringe Volume	PTFE Tipped Plunger	Needle Length (mm)	Needle Gauge	Needle OD (mm)	Needle ID (mm)	Needle Tip	Syringe Code	Replacement Needle Part No.	Replacement Plunger Part No.
Removable Needle										
003985	25 µL	✓	51	22	0.72	0.37	LC	25R-C/F-GT-LC	038250	031816
005330	100 µL	✓	51	22	0.72	0.37	LC	100R-C/F-GT-LC	038250	031826
006330	250 µL	✓	51	22	0.72	0.37	LC	250R-C/F-GT-LC	038250	031831
008120	1 mL	✓	51	22	0.72	0.4	LC	1MR-CTC-GT-LC(0.4)	039180	0318444
008620	2.5 mL	✓	51	22	0.72	0.4	LC	2.5MR-CTC-GT-LC(0.4)	039182	0318454
008820	5 mL	✓	51	22	0.72	0.4	LC	5MR-CTC-GT-LC(0.4)	031525	0318564

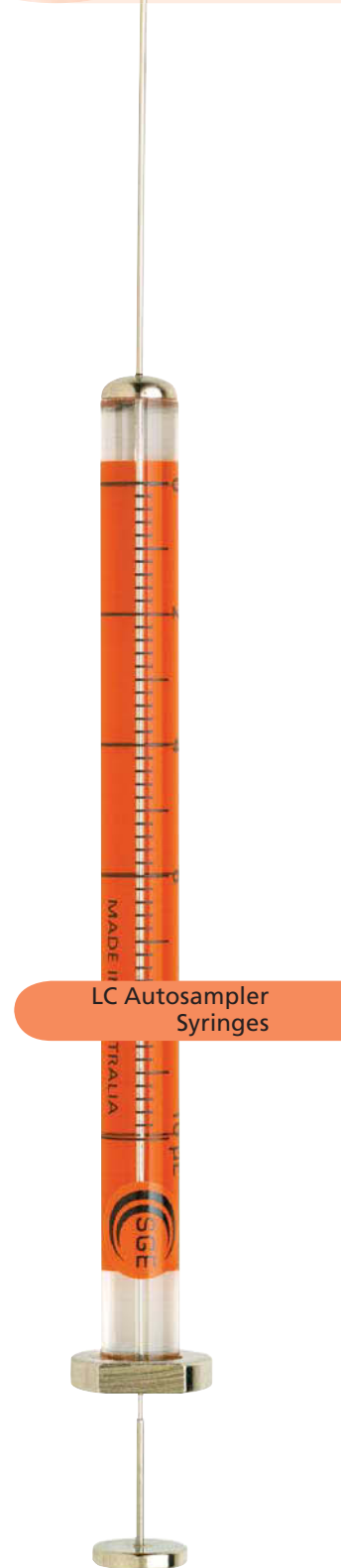

LC Autosampler Syringes





SPECIFICATIONS

Accuracy and Reproducibility
± 1 % (dispensed volume)

Borosilicate Glass Barrel Outer Diameter (OD)
50 µL to 500 µL = 8 mm, 1 mL = 9 mm, 2.5 mL = 11 mm

Scale Length
60 mm

International Standards Traceability

LC Autosampler Syringes | PerkinElmer Instruments

Syringe Part No.	Syringe Volume	PTFE Tipped Plunger	Front Thread	Syringe Code	Replacement Plunger Part No.
004995	50 µL	✓	1/4-28 UNF	50D-CX-GT	0318221
005990	100 µL	✓	1/4-28 UNF	100D-CX-GT	0318271
006995	250 µL	✓	1/4-28 UNF	250D-CX-GT	0318341
007995	500 µL	✓	1/4-28 UNF	500D-CX-GT	0318381
008185	1 mL	✓	1/4-28 UNF	1MD-C-GT	0318441
008687	2.5 mL	✓	1/4-28 UNF	2.5MD-C-GT	031854



SPECIFICATIONS

Accuracy and Reproducibility
± 1 % (dispensed volume)

Borosilicate Glass Barrel Outer Diameter (OD)
250 µL = 8 mm, 1 mL = 9 mm

Scale Length
60 mm

International Standards Traceability

LC Autosampler Syringes | Spark Holland Instruments

Syringe Part No.	Syringe Volume	PTFE Tipped Plunger	Front Thread	Syringe Code	Replacement Plunger Part No.
006683	250 µL	✓	1/4-28 UNF	250D-SPARK-GT	0318348
008183	1 mL	✓	1/4-28 UNF	1MD-SPARK-GT	0318448



SPECIFICATIONS

Accuracy and Reproducibility
± 1 % (dispensed volume)

Borosilicate Glass Barrel Outer Diameter (OD)
250 µL and 500 µL = 8 mm, 1 mL = 9 mm, 2.5 mL = 11 mm, 5 mL = 14 mm

Scale Length
No scale

International Standards Traceability



LC Autosampler Syringes | Thermo Scientific Instruments

Syringe Part No.	Syringe Volume	PTFE Tipped Plunger	Front Thread	Syringe Code	Replacement Plunger Part No.
SP8780/8875/8880					
007680	500 µL	✓	1/4-28 UNF	500C-THERMOSPEC	031838
008660	2.5 mL	✓	1/4-28 UNF	2.5MC-THERMOSPEC	031853
AS100/300 and AS1000/3000/3500					
006660	250 µL	✓	1/4-28 UNF	250C-THERMOSPEC	031833
007680	500 µL	✓	1/4-28 UNF	500C-THERMOSPEC	031838
008180	1 mL	✓	1/4-28 UNF	1MC-THERMOSPEC	031844
008660	2.5 mL	✓	1/4-28 UNF	2.5MC-THERMOSPEC	031853
008780	5 mL	✓	1/4-28 UNF	5MC-THERMOSPEC	031856



LC Autosampler Syringes



SPECIFICATIONS

Accuracy and Reproducibility
± 1 % (dispensed volume)

Borosilicate Glass Barrel Outer Diameter (OD)
8 mm

Scale Length
No scale

International Standards Traceability

LC Autosampler Syringes | Waters Instruments

Syringe Part No.	Syringe Volume	PTFE Tipped Plunger	Front Thread	Syringe Code	Replacement Plunger Part No.
003990	25 µL	✓	1/4-28 UNF	25D-WISP	031819
006690	250 µL	✓	1/4-28 UNF	250D-WISP	031834

WISP Dipper Needle

Part No.	Needle Length (mm)	Needle OD (mm)	Needle ID (mm)	Needle Tip	Description
038265	121	1.587	0.5	Side Hole Cone	N-121/1.59(0.5)SH

LC Pump High Capacity Syringes



SPECIFICATIONS

Accuracy and Reproducibility
± 1 % (dispensed volume)

Borosilicate Glass Barrel Outer Diameter (OD)
1 mL = 9 mm, 2.5 mL = 11 mm, 5 mL = 14 mm
10 mL = 18 mm, 25 mL = 27 mm

Scale Length
60 mm

International Standards Traceability

LC Pump High Capacity Syringes

High capacity Luer Lock syringes are ideal for loop fill injection techniques when used in conjunction with an LC tipped Luer Lock needle. They are also perfect for flushing sample loops after injection, and priming the LC pump.

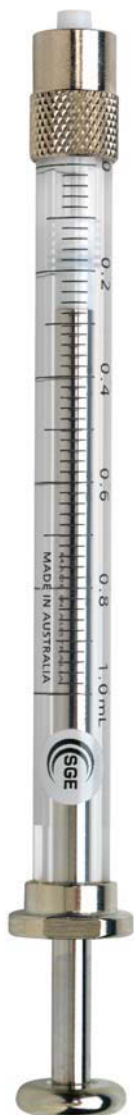

Syringe Part No.	Syringe Volume	PTFE Tipped Plunger	Termination	Syringe Code	Replacement Plunger Part No.
008025	1 mL	✓	Fixed Luer Lock	1MDF-LL-GT	0318441
008425	2.5 mL	✓	Fixed Luer Lock	2.5MDF-LL-GT	031852
008762	5 mL	✓	Fixed Luer Lock	5MDF-LL-GT	0318562
008962	10 mL	✓	Fixed Luer Lock	10MDF-LL-GT	031864
009463	25 mL	✓	Fixed Luer Lock	25MDF-LL-GT	031874



Part No.	Description	Pack Size
200010	Luer Lock Valve Adaptor	2

Expert Tip:

For complete loop fill, the syringe capacity should be greater than twice the loop volume. The loop capacity sets the injection volume. For partial loop fill, the injection volume should be no greater than half the loop capacity. The injection size sets the injection volume.



Instrument Syringes

SPECIFICATIONS

Accuracy and Reproducibility
± 1 % (dispensed volume)

Borosilicate Glass Barrel Outer Diameter (OD)
1 mL = 8.8 mm, 2.5 mL = 10.8 mm, 5 mL = 13.7 mm,
10 mL = 18 mm, 25 mL = 27 mm, 50 mL = 32.6 mm, 100 mL = 40.6 mm

Scale Length
60 mm

International Standards Traceability

Instrument Syringes | 1 - 100 mL PTFE Tipped Plunger

Also Suitable for Dispenser and Manual Use



Syringe Part No.	Syringe Volume	PTFE Tipped Plunger	Needle Length (mm)	Needle Gauge	Needle OD (mm)	Needle ID (mm)	Needle Tip	Syringe Code	Replacement Needle Part No.	Replacement Plunger Part No.
Fixed Needle										
008102	1 mL	✓	50	22	0.72	0.37	Bevel	1MDF-GT	-	0318441
008502	2.5 mL	✓	50	22	0.72	0.37	Bevel	2.5MDF-GT	-	031852
Removable Needle										
008100	1 mL	✓	50	23	0.63	0.32	Bevel	1MR-GT	039110	031842
008500	2.5 mL	✓	50	23	0.63	0.32	Bevel	2.5MDR-GT	039110	031852
008700	5 mL	✓	50	23	0.63	0.32	Bevel	5MDR-GT	031516	031856
008900	10 mL	✓	50	23	0.63	0.32	Bevel	10MDR-GT	031516	031862
Fixed Luer Tip										
008020	1.0 mL	✓	-	-	-	-	Luer Tip	1MF-LT-GT	-	031842
008420	2.5 mL	✓	-	-	-	-	Luer Tip	2.5MDF-LT-GT	-	031852
Fixed Luer Lock										
008025	1.0 mL	✓	-	-	-	-	Luer Lock	1MDF-LL-GT	-	0318441
008425	2.5 mL	✓	-	-	-	-	Luer Lock	2.5MDF-LL-GT	-	031852
008762	5 mL	✓	-	-	-	-	Luer Lock	5MDF-LL-GT	-	0318562
008962	10 mL	✓	-	-	-	-	Luer Lock	10MDF-LL-GT	-	031864
009463	25 mL	✓	-	-	-	-	Luer Lock	25MDF-LL-GT	-	031874
Removable Luer Lock										
008760	5 mL	✓	-	-	-	-	Luer Lock	5MDR-LL-GT	-	031856
008960	10 mL	✓	-	-	-	-	Luer Lock	10MDR-LL-GT	-	031862
009462	25 mL	✓	-	-	-	-	Luer Lock	25MR-LL-GT	-	031870
009660	50 mL	✓	-	-	-	-	Luer Lock	50MR-LL-GT	-	0312170
009760	100 mL	✓	-	-	-	-	Luer Lock	100MR-LL-GT	-	0312176



SPECIFICATIONS

Accuracy and Reproducibility
± 1 % (dispensed volume)

Borosilicate Glass Barrel Outer Diameter (OD)
25 µL to 500 µL = 8mm, 1 mL = 8.8 mm, 2.5 mL = 10.8 mm,
5 mL = 13.7 mm, 10 mL = 18 mm

Scale Length
60 mm

International Standards Traceability



Instrument Syringes | General

Replacement for Hamilton C and CX Syringes

Syringe Part No.	Syringe Volume	PTFE Tipped Plunger	Termination	Syringe Code	Replacement Plunger Part No.
003995	25 µL	✓	1/4-28 UNF	25D-CX	0318191
004995	50 µL	✓	1/4-28 UNF	50D-CX	0318221
005990	100 µL	✓	1/4-28 UNF	100D-CX	0318271
006995	250 µL	✓	1/4-28 UNF	250D-CX	031833
007995	500 µL	✓	1/4-28 UNF	500D-CX	0318381
008185	1 mL	✓	1/4-28 UNF	1MD-C	0318441
008687	2.5 mL	✓	1/4-28 UNF	2.5MD-C	031854
008787	5 mL	✓	1/4-28 UNF	5MD-C	0318591
008987	10 mL	✓	1/4-28 UNF	10MD-C	0318631

Syringe Part No.	Syringe Volume	PTFE Tipped Plunger	Termination	Syringe Code	Replacement Plunger Part No.
004232	50 µL	✓	Luer Lock	50F-LLX-GT	0318221
005232	100 µL	✓	Luer Lock	100F-LLX-GT	0318271
006232	250 µL	✓	Luer Lock	250F-LLX-GT	031833
007232	500 µL	✓	Luer Lock	500F-LLX-GT	0318381
008025	1 mL	✓	Luer Lock	1MDF-LL-GT	0318441
008425	2.5 mL	✓	Luer Lock	2.5MDF-LL-GT	031852
008762	5 mL	✓	Luer Lock	5MDF-LL-GT	0318562
008962	10 mL	✓	Luer Lock	10MDF-LL-GT	031864
009463	25 mL	✓	Luer Lock	25MDF-LL-GT	031874



Instrument Syringes





SPECIFICATIONS

Accuracy and Reproducibility
± 1 % (dispensed volume)

Borosilicate Glass Barrel Outer Diameter (OD)
1 mL = 9 mm, 5 mL = 14 mm

Scale Length
60 mm

International Standards Traceability

Instrument Syringes | Grabner

Syringe Part No.	Syringe Volume	PTFE Tipped Plunger	Termination	Syringe Code	Replacement Plunger Part No.
008020	1 mL	✓	Luer Tip	1MDF-LT-GT	031842
008790	5 mL	✓	Luer Lock	5MDF-GRABNER-GT	031858

SPECIFICATIONS

Accuracy and Reproducibility
± 1 % (dispensed volume)

Borosilicate Glass Barrel Outer Diameter (OD)
250 µL = 8 mm

Scale Length
60 mm

International Standards Traceability

Instrument Syringes | Shimadzu Total Organic Carbon Analyzer - TOC5000



Syringe Part No.	Syringe Volume	PTFE Tipped Plunger	Termination	Syringe Code	Replacement Plunger Part No.
006680	250 µL	✓	1/4-28 UNF	250C-SHIM (TOC)	031832

SPECIFICATIONS

Accuracy and Reproducibility
± 1 % (dispensed volume)

Borosilicate Glass Barrel Outer Diameter (OD)
5 mL = 14 mm, 10 mL = 18 mm

Scale Length
60 mm

International Standards Traceability

Instrument Syringes | Zymark



Syringe Part No.	Syringe Volume	PTFE Tipped Plunger	Termination	Syringe Code	Replacement Plunger Part No.
008792	5 mL	✓	Slotted Luer Lock	5MD-ZYMARK-GT	0318562
008992	10 mL	✓	Slotted Luer Lock	10MD-ZYMARK-GT	031864

Syringe Accessories



Syringe Accessories | Repeating Adaptor

The SGE Repeating Adaptor (RAX) ensures reproducibility of sample volumes with repeatedly accurate and precise injections.

The RAX is suitable for use on syringes with capacities from 0.5 μL through to 500 μL . It has easy to use finger grips and can be set to any desired volume. The RAX can be used as added protection against both plunger blowout at elevated pressures and plunger bending. The flat sides allow it to sit securely on the bench with the needle in a raised position helping to prevent damage. The RAX is supplied with an innovative double-ended tool to facilitate assembly; it is easily and quickly installed on, and if required, removed, replaced and even swapped between syringes.

Part No.	Description
031930	Repeating Adaptor RAX

Syringe Accessories | Syringe Racks

Syringe racks organize your syringes and ensure that they do not roll off the bench or top of the instrument and break. A must for every laboratory.

Part No.	Description
031776	Syringe rack holds 6 syringes
031786	Syringe rack holds 6 XCHANGE [®] syringes





Syringe Accessories | Heated Syringe Cleaner



Ensure organic sample residues are vaporized out of the needle, preventing ghost peaks and cross contamination, by using the SGE heated syringe cleaner.

The heated syringe cleaner is especially useful for NanoVolume syringes where the entire sample is confined to the needle.

Operation is simple. Insert the needle through the septum into the heated zone, hold for

approximately 30 seconds and then pump the plunger a few times to vaporize contaminants away. The device will accept needles up to 1 mm OD and 100 mm long.

The cleaner has a very short warm-up period; it takes approximately 20 minutes to reach the operating temperature (250 °C). The unit is thermostatically controlled for continuous use if required.

A vacuum source of approximately 10 Torr from a water pump or mechanical pump should be connected to the unit.

Expert Tip :

Ghost peaks or cross-contamination can be caused by a 'dirty' needle. Using the SGE heated syringe cleaner can eliminate this.



Part No.	Description
031780	110-120 V Syringe Cleaner
031781	220-240 V Syringe Cleaner



Syringe Accessories | Needle Cleaning Kit

Everything needed for thorough needle cleaning. A range of stylet wires, tweezers for holding the wires and a non-ionic surfactant material are provided in a convenient package.

Part No.	Description
031782	Needle Cleaning Kit Kit contains: Tube of Stylet Wires 150 mm x 0.10 mm OD Tube of Stylet Wires 150 mm x 0.15 mm OD Tube of Stylet Wires 150 mm x 0.20 mm OD 20 mL Cleaning Solution Concentrate Tweezer

Syringe Accessories | Stylet Wires

Stylet wires are used for cleaning the inside of needles and are available in 3 sizes – check the needle internal diameter of the syringe to select the suitable wires (the needle ID is listed for syringes throughout this selection guide).

Part No.	Description	Pack Size
031745	Stylet Wires 150 mm x 0.10 mm OD	5
031746	Stylet Wires 150 mm x 0.15 mm OD	5
031747	Stylet Wires 150 mm x 0.20 mm OD	5

Replacement Guide

Replacement Guide | Needles

A variety of replacement needles are available for each syringe capacity. The needle length, gauge and tip style can be changed to optimize the syringe for a wide range of applications.

For tips on needle selection refer to page 3.

For needles for 5 μ L eVol[®] syringes refer to page 19.



Part No.	Needle Length (mm)	Gauge	Needle OD (mm)	Needle ID (mm)	Tip Style	Needle Code	Pack Size
5 μL Syringe							
036010	50	26	0.47	0.11	Cone	N5-5C	2
036011	50	23	0.63	0.11	Cone	N5-5/0.63C	2
036030	70	26	0.47	0.11	Cone	N5-7C	2
036031	70	23	0.63	0.11	Cone	N5-7-0.63C	2
036060	115	26	0.47	0.11	Cone	N5-11.5C	2
036110	50	26	0.47	0.11	Bevel	N5-5	5
036130	70	26	0.47	0.11	Bevel	N5-7	5
036160	115	26	0.47	0.11	Bevel	N5-11.5	5
036250	51 (2")	22	0.028"	0.17	LC	N5-LC	5
036310	50	26	0.47	0.11	Sheathed/Bevel	N5-5T	2
036410	50	26	0.47	0.11	Side Hole/Dome	N5-5H	2
036510	50	26	0.47	0.11	Dome	N5-5D	2
036530	70	26	0.47	0.11	Dome	N5-7D	2
036603	50	-	0.17	0.1	On-Column	N5-OC-5/0.17VS	2
036605	75	-	0.17	0.1	On-Column	N5-OC-7.5/0.17VS	2
036610	100	-	0.17	0.1	On-Column	N5-OC-10/0.17VS	2
036625	110	-	0.17	0.1	On-Column	N5-OC-11/0.17VS	2
036635	100	-	0.17	0.1	On-Column	N5-OC-10/0.17SVS	2
036651	107	-	0.19	0.1	On-Column	N5-OC-10.7/0.19S	2
036675	75	-	0.23	0.1	On-Column	N5-OC-7.5/0.23	2
036685	95	-	0.27	0.11	On-Column	N5-OC-9.5/0.27 SSS	2
036701	50	-	0.19	0.1	On-Column	N5-HP-OC-0.19	2
036703	50	-	0.23	0.11	On-Column	N5-HP-OC-0.23	2
036710	42	26	0.47	0.11	Cone	N5-HP-0.47	2
036720	42	23	0.63	0.11	Cone	N5-HP-0.63	2
036730	42	23/26	0.63/0.47	0.11	Cone	N5-HP-.63/0.47	2
10 μL Syringe							
037010	50	26	0.47	0.11	Cone	N10-5C	2
037011	50	23	0.63	0.11	Cone	N 10-5/0.63C	2
037030	70	26	0.47	0.11	Cone	N10-7C	2
037031	70	23	0.63	0.11	Cone	N10-7/0.63C	2
037060	115	26	0.47	0.11	Cone	N10-11.5C	2
037110	50	26	0.47	0.11	Bevel	N10-5	5
037111	50	23	0.63	0.11	Bevel	N10-5/0.63	5
037130	70	26	0.47	0.11	Bevel	N10-7	5
037160	115	26	0.47	0.11	Bevel	N10-11.5	5
037250	51 (2")	22	0.028"	0.17	LC	N10-LC	5
037260	50	25	0.5	0.12	LC	N10-WLC	5
037270	70	22	0.028"	0.17	LC	N10-LC-7	5
037310	50	26	0.47	0.11	Sheathed/Bevel	N10-5T	2
037330	70	26	0.47	0.11	Sheathed/Bevel	N10-7T	2
037410	50	26	0.47	0.11	Side Hole/Dome	N10-5H	2
037510	50	26	0.47	0.11	Dome	N10-5D	2
037540	75	26	0.47	0.11	Dome	N10-7.5D	2
037605	75	-	0.17	0.1	On-Column	N10-OC-7.5/0.17VS	2
037610	100	-	0.17	0.1	On-Column	N10-OC-10/0.17VS	2
037675	75	-	0.23	0.1	On-Column	N10-OC-7.5/0.23	2
037715	42	26	0.47	0.11	Cone	N10-HP-0.47	2
037717	42	23	0.63	0.11	Cone	N10-HP-0.63	2
037730	42	23/26	0.63/0.47	0.11	Cone	N10-HP0.63/0.47	2

Part No.	Needle Length (mm)	Gauge	Needle OD (mm)	Needle ID (mm)	Tip Style	Needle Code	Pack Size
10 µL Syringe Cont.							
037736	50	26	0.47	0.11	Cone	N10-S(9)-0.47	2
037745	42	26	0.47	0.11	Cone	N10-S-0.47	2
037747	42	23	0.63	0.11	Cone	N10-S-0.63	2
037775	50	25	0.5	0.11	Dome	N10-VA8000-II	2
037776	50	25	0.5	0.11	Bevel	N10-VA8035-II	2
037777	53	25	0.5	0.11	Side Hole/Dome	N10-VA8X00H-II	1
037778	105	-	0.17	0.11	On-Column	N10-VA8035-0.17-II	2
037779	53	23	0.63	0.11	Side Hole/Cone	N10-VA8X00H-0.63-II	2
037780	50	25	0.5	0.2	Side Hole/Dome	N10-VA800H-II	1
037785	50	26	0.47	0.15	Cone	N10-C/F-5/0.47C	2
037787	50	23	0.63	0.11	Cone	N10-C/F-0.63	2
25 - 500 µL Syringe and 500 µL eVol® Syringe							
031536	80	25	0.5	0.20	Cone	N25/500-C/F-8/0.5C	3
038030	70	25	0.5	0.20	Cone	N25/500-7C	2
038060	115	25	0.5	0.20	Cone	N25/500-11.5C	2
038110	50	25	0.5	0.20	Bevel	N25/500-5	5
038111	50	23	0.63	0.24	Bevel	N25/500-5/0.63	5
038130	70	25	0.5	0.20	Bevel	N25/500-7	5
038131	70	23	0.63	0.24	Bevel	N25/500-7/0.63	5
038160	115	25	0.5	0.20	Bevel	N25/500-11.5	5
038161	115	23	0.63	0.24	Bevel	N25/500-11.5/0.63	5
038250	51 (2")	22	0.028"	0.37	LC	N25/500-LC	5
038260	50	25	0.5	0.20	LC	N25/500-WLC	5
038270	70	22	0.028"	0.37	LC	N25/500-LC-7	5
038310	50W	25	0.5	0.20	Sheathed/Bevel	N25/500-5T	2
038410	50	25	0.5	0.20	Side Hole/Dome	N25/500-5H	2
038430	70	25	0.5	0.20	Side Hole/Dome	N25/500-7H	2
038460	115	25	0.5	0.20	Side Hole/Dome	N25/500-11.5H	2
038510	50	25	0.5	0.20	Dome	N25/500-5D	2
038530	70	25	0.5	0.20	Dome	N25/500-7D	2
038717	42	23	0.63	0.24	Cone	N25/500-HP-0.63	2
038730	50	23	0.63	0.15	Bevel	N25/500-C/F-0.63/5	5
038732	50	26	0.47	0.2	Cone	N25/500-C/F-5/0.47C	2
038735	50	23	0.63	0.15	Cone	N25/500-C/F-5/0.63C	2
038745	53	25	0.5	0.15	Side Hole/Dome	N25/500-VAR-5.3/0.5H	1
038910	50	25	0.5	0.20	PTFE Coated	N25/500-5P	2
1 - 2.5 mL Syringe and 500 µL eVol® Syringe							
039110	50	23	0.63	0.32	Bevel	NM1/2.5-5	5
039116	50	23	0.63	0.32	Dome	NM1/2.5-5/0.63D	2
039115	50	22	0.028"	0.37	Bevel	NM1/2.5-5/22BV	5
039120	50	23	0.63	0.32	Side Hole/Dome	NM1/2.5-5-0.63H	2
039130	70	23	0.63	0.32	Bevel	NM1/2.5-7	5
039160	115	23	0.63	0.32	Bevel	NM1/2.5-11.5	5
039250	51 (2")	22	0.028"	0.37	LC	NM1/2.5-LC	5
039260	50	25	0.5	0.20	LC	NM1/2.5-WLC	5
5-10 mL Syringe							
031516	50	23	0.63	0.32	Bevel	NM5/10-5	2
031521	70	23	0.63	0.32	Bevel	NM5/10-7	5
0315233	51 (2")	22	0.028"	0.37	LC	NM5/10-LC	5
0315234	50	24	0.5	0.2	LC	NM5/10-WLC	5
Luer Lock Needles							
039120	50	23	0.63	0.32	Side Hole/Dome	NM1/2.5-5-0.63H	2
039802	50	23	0.63	0.32	Bevel	NLL-5/23	5
039803	50	23	0.63	0.32	Side Hole/Dome	NLL-5/23H	2
039807	70	23	0.63	0.32	Bevel	NLL-7/23	5
039808	70	23	0.63	0.32	Side Hole/Dome	NLL-7/23H	2
039811	115	23	0.63	0.32	Bevel	NLL-11.5/23	5
039822	50	19	1.07	0.65	Bevel	NLL-5/19	5
039823	50	19	1.07	0.65	Side Hole/Dome	NLL-5/19H	2
039827	70	19	1.07	0.65	Bevel	NLL-7/19	5
039831	115	19	1.07	0.65	Bevel	NLL-11.5/19	5
039842	50	18	1.27	0.80	Bevel	NLL-5/18	5
039847	70	18	1.27	0.80	Bevel	NLL-7/18	5
039851	115	18	1.27	0.80	Bevel	NLL-11.5/18	5
039862	50	16	1.57	1.1	Bevel	NLL-5/16	5
039867	70	16	1.57	1.1	Bevel	NLL-7/16	5
039871	115	16	1.57	1.1	Bevel	NLL-11.5/16	5
039880	50	14	2.1	1.6	Bevel	NLL-5/14	5
039891	115	14	2.1	1.6	Bevel	NLL-11.5/14	5
039895	51 (2")	22	0.028"	0.37	LC	NLL-LC	2
039897	50	25	0.5	0.20	LC	NLL-WLC	2



Replacement Guide | NanoVolume Syringe Plunger and Needle Kits

Kits are available for 0.5 µL- 5.0 µL NanoVolume syringes. The kits are supplied with a matched plunger and needle, both must be replaced together. A list of replacement kits is below. Find the SGE syringe part number to determine the appropriate replacement plunger and needle kit.

Replacement Plunger/ Needle Kit Part No.	Needle Length (mm)	Needle Gauge	Needle OD (mm)	Needle ID (mm)	Needle Tip	Description	Syringe Part No.
0.5 µL Syringes, 6.5 mm OD Barrel							
033010	50	23	0.63	0.15	Cone	NP0.5BN-5/0.63C	000300
033011	50	23	0.63	0.15	Bevel	NP0.5BN-5/0.63BV	000301
033012	50	26	0.47	0.15	Cone	NP0.5BN-5/0.47C	000303
0.5 µL Syringes, 8mm OD Barrel							
033057	70	23	0.63	0.1	Cone	NP0.5B-7C	000310
033060	70	23	0.63	0.1	Bevel	NP0.5B-7BV	000311
033605	100	-	0.23	0.1	Cone	NP0.5B-OC-10/0.23	-
033610	100	-	0.23	0.1	Cone	NP0.5B-OC-10/0.23T (Sheathed)	000372
033620	75	26	0.23	0.1	Cone	NP0.5B-OC-7.5/0.23	000380
033630	70	26	0.47	0.1	Cone	NP0.5B-OC-7/0.47	000376
1 µL Syringes, 8 mm OD Barrel							
034055	50	23	0.63	0.15	Cone	NP1B-5C	000500
034056	50	23	0.63	0.15	Bevel	NP1B-5BV	000501
034057	70	23	0.63	0.15	Cone	NP1B-7C	000505
034059	115	23	0.63	0.15	Cone	NP1B-11.5C	000510
034060	70	23	0.63	0.15	Bevel	NP1B-7BV	000506
034610	70	26	0.47	0.15	Cone	NP1B-OC-7/0.47	000570
5 µL Syringes, 8 mm OD Barrel							
035055	50	23	0.63	0.37	Cone	NP5B-5C	000800
035056	50	23	0.63	0.37	Bevel	NP5B-5BV	000801
035057	70	23	0.63	0.37	Cone	NP5B-7C	000802
035058	70	23	0.63	0.37	Bevel	NP5B-7BV	000803
035059	115	23	0.63	0.37	Cone	NP5B-11.5C	000804

Expert Tip:

When replacing the plunger and needle follow the instructions included in the kit – the front cover nut must be loosened before removing the plunger.



Replacement Guide | Autosampler NanoVolume Syringes

Replacement Plunger/ Needle Kit Part No.	Syringe Volume	Needle Length (mm)	Needle Gauge	Needle OD (mm)	Needle ID (mm)	Needle Tip	Description	Syringe Part No.
7673, 7683 and 6850 ALS Syringes								
033708	0.5 µL	42	26	0.47	0.15	Cone	NP0.5B-HP-0.47	000400
033715	0.5 µL	42	23	0.63	0.15	Cone	NP0.5B-HP-0.63	000410
033730	0.5 µL	42	23/26	0.63/0.47	0.1	Cone	NP0.5B-HP-0.63/0.47	000415
034715	1 µL	42	23	0.63	0.15	Cone	NP1B-HP-0.63	000610
CTC/Leap and Thermo Scientific								
033770	0.5 µL	50	26	0.47	0.15	Cone	NP0.5BN-C/T-0.47C	000490
033772	0.5 µL	50	23	0.63	0.15	Cone	NP0.5BN-C/T-0.63C	000492
PerkinElmer - AutoSystem and Clarus 500								
033750	0.5 µL	70	26	0.47	0.15	Cone/ Bevel	NP0.5B-PE-0.47	000475
033765	0.5 µL	70	23	0.63	0.15	Cone	NP0.5B-PE-0.63	000478
Shimadzu - AOC 14, 17, 20 and 20i								
033738	0.5 µL	42	26	0.47	0.15	Cone	NP0.5B-S-0.47	000440
033745	0.5 µL	42	23	0.63	0.15	Cone	NP0.5B-S-0.63	000445

Replacement Guide | Syringe Components

Part No.	Description	Pack Size
031902	Replacement Luer Lock Fitting (includes Kel-F Luer Cone and threaded Metal Adaptor)	1
031903	Replacement Kel-F Luer Cones	2
032002	Replacement PTFE Plunger Seal (supplied with tool) for 0.5 µL NanoVolume syringes with 8 mm OD Barrels	1
032004	Replacement PTFE Plunger Seal (supplied with tool) for 0.5 µL NanoVolume syringes with 6.5 mm OD barrels and 1 µL NanoVolume syringes	1
032006	Replacement PTFE Plunger Seal (supplied with tool) for 5 µL NanoVolume syringes	1
032012	Replacement Needle Seals 5 µL Syringes	2
032014	Replacement Needle Seals 10 µL Syringes	2
032016	Replacement Needle Seals 15 to 500 µL Syringes	2
032018	Replacement Needle Seals 1 to 2.5 mL Syringes	2
032030	Replacement Needle Springs	10
032040	Front Cover Nut for Removable Needle Syringes with 6.5 mm OD Barrel	2
032042	Front Cover Nut for Removable Needle Syringes with 8 mm OD Barrel	2



Replacement Guide | Plungers Listed by Syringe Part Number

Syringe Part No.	Replacement Plunger Part No.	Plunger Code	Pack Size	Syringe Part No.	Replacement Plunger Part No.	Plunger Code	Pack Size
001955	031807	P5F-PE-GT 5 µL	2	006690	031834	P250-WISP-GT 250 µL	1
001957	031807	P5F-PE-GT 5 µL	2	006700	0318926	P250F-CTC-GT	1
002200	031810	P10F-GT 10 µL	2	006720	0318926	P250F-CTC-GT	1
002208	031810	P10F-GT 10 µL	2	006995	031833	P250-THERMO 250 µL	1
002250	031811	P10R-GT 10 µL	2	007200	031835	P500-GT 500 µL	1
002313	031811	P10R-GT 10 µL	2	007229	031835	P500-GT 500 µL	1
002335	031810	P10F-GT 10 µL	2	007230	031835	P500-GT 500 µL	1
002455	031805	P10-GP-GT 10 µL	2	007232	0318381	P500D-CX 500 µL	1
002500	031811	P10R-GT 10 µL	2	007250	031835	P500-GT 500 µL	1
002812	031808	P10F-HP-GT 10 µL	2	007279	031835	P500-GT 500 µL	1
002817	031809	P10R-HP-GT 10 µL	2	007312	031835	P500-GT 500 µL	1
002818	031809	P10R-HP-GT 10 µL	2	007630	031835	P500-GT 500 µL	1
002826	031808	P10F-HP-GT 10 µL	2	007660	031837	P500-HITACHI 500 µL	1
002829	031809	P10R-HP-GT 10 µL	2	007680	0318381	P500D-CX 500 µL	1
002902	031798	P10R-S-GT	2	007684	0318389	P500D-KONTRON-GT	1
002923	031218	10A-VP 10 µL	1	007700	0318928	P500F-CTC-GT	1
002924	031218	10A-VP 10 µL	1	007720	0318928	P500F-CTC-GT	1
002926	031218	10A-VP 10 µL	1	007995	0318381	P500D-CX 500 µL	1
002985	0318922	P25F-CTC-GT	2	008020	031842	P1M-GT 1 mL	1
002987	0318120	P10F-C/T-GT 10 µL	2	008025	0318441	P1MD-C-GT 1 mL	1
002991	0318120	P10F-C/T-GT 10 µL	2	008100	031842	P1M-GT 1 mL	1
003200	031815	P25-GT 25 µL	1	008102	0318441	P1MD-C-GT 1 mL	1
003250	031815	P25-GT 25 µL	1	008105	031842	P1M-GT 1 mL	1
003312	031815	P25-GT 25 µL	1	008110	031842	P1M-GT 1 mL	1
003668	031818	P25-HP-GT 25 µL	1	008120	0318444	P1MD-CTC-GT 1 mL	1
003670	0318181	P25-HP1090-GT 25 µL	1	008140	0318443	P1MD-LL-CAV (XL)	1
003700	0318922	P25F-CTC-GT	1	008160	031842	P1M-GT 1 mL	1
003715	0318922	P25F-CTC-GT	1	008183	0318448	P1MD-SPARK-GT 1 mL	1
003985	031816	P25R-C/T-GT 25 µL	1	008184	0318449	P1MD-KONTRON-GT	1
003987	031817	P25F-C/T-GT 25 µL	1	008185	0318441	P1MD-C-GT 1 mL	1
003988	031816	P25R-C/T-GT 25 µL	1	008195	031842	P1M-GT 1 mL	1
003990	031819	P25-WISP-GT 25 µL	1	008199	031842	P1M-GT 1 mL	1
003995	0318191	P25D-CX 25 µL	1	008420	031852	P2.5MD-GT 2.5 mL	1
004200	031820	P50-GT 50 µL	1	008425	031852	P2.5MD-GT 2.5 mL	1
004229	031820	P50-GT 50 µL	1	008500	031842	P1M-GT 1 mL	1
004230	031820	P50-GT 50 µL	1	008502	031852	P2.5MD-GT 2.5 mL	1
004232	0318221	P50D-CX 50 µL	1	008505	031852	P2.5MD-GT 2.5 mL	1
004233	0318221	P50D-CX 50 µL	1	008510	031852	P2.5MD-GT 2.5 mL	1
004250	031820	P50-GT 50 µL	1	008560	031852	P2.5MD-GT 2.5 mL	1
004279	031820	P50-GT 50 µL	1	008584	0318549	P2.5MD-KONTRON-GT	1
004312	031820	P50-GT 50 µL	1	008660	031853	P2.5M-THERMO 2.5 mL	1
004668	031142	P50F-HP-GT	1	008685	0318545	P2.5MD-LL-CAV(XL)	1
004810	031821	P50F-C/T-GT 50 µL	1	008692	031852	P2.5MD-GT 2.5 mL	1
004995	0318221	P50D-CX 50 µL	1	008700	031856	P5MD-GT 5 mL	1
005200	031825	P100-GT 100 µL	1	008760	031856	P5MD-GT 5 mL	1
005229	031825	P100-GT 100 µL	1	008762	0318562	P5MDF-GT 5 mL	1
005230	031825	P100-GT 100 µL	1	008770	031856	P5MD-GT 5 mL	1
005232	0318271	P100D-CX 100 µL	1	008775	031856	P5MD-GT 5 mL	1
005236	031825	P100-GT 100 µL	1	008780	031856	P5MD-GT 5 mL	1
005250	031825	P100-GT 100 µL	1	008785	0318595	P5MD-LL-CAV (XL)	1
005279	031825	P100-GT 100 µL	1	008787	0318562	P5MDF-GT 5 mL	1
005312	031825	P100-GT 100 µL	1	008790	031858	P5M-GRABNER 5 mL	1
005330	031826	P100R-C/T-GT 100 µL	1	008792	0318597	P5MD-ZYMARK-GT	1
005331	0318261	P100F-C/T-GT 100 µL	1	008820	031856	P5MD-GT 5 mL	1
005333	031826	P100R-C/T-GT 100 µL	1	008900	031862	P10MD-GT 10 mL	1
005335	0318261	P100F-C/T-GT 100 µL	1	008960	031862	P10MD-GT 10 mL	1
005668	031823	P100-HP-GT 100 µL	1	008962	031864	P10MDF-LL 10 mL	1
005700	0318924	P100F-CTC-GT	1	008970	031862	P10MD-GT 10 mL	1
005720	0318924	P100F-CTC-GT	1	008975	031862	P10MD-GT 10 mL	1
005921	031824	P100-VA8X 100 µL	1	008985	0318635	P10MD-LL-CAV(XL)	1
005990	0318271	P100D-CX 100 µL	1	008987	031864	P10MDF-LL 10 mL	1
006200	031830	P250-GT 250 µL	1	008992	031864	P10MDF-LL 10 mL	1
006229	031830	P250-GT 250 µL	1	009462	031870	P25MD-GT 25 mL	1
006230	031830	P250-GT 250 µL	1	009463	031874	P25MDF-GT 25 mL	1
006232	031833	P250-THERMO 250 µL	1	009472	031870	P25MD-GT 25 mL	1
006250	031830	P250-GT 250 µL	1	009485	0318715	P25MD-LL-CAV(XL)	1
006279	031830	P250-GT 250 µL	1	009660	0312170	50MAX-P 50 mL	1
006312	031830	P250-GT 250 µL	1	009670	0312170	50MAX-P 50 mL	1
006330	031831	P250R-C/T-GT 250 µL	1	009760	0312176	100MAX-P 100 mL	1
006660	031833	P250-THERMO 250 µL	1	009770	0312176	100MAX-P 100 mL	1
006670	031829	P250-HP1090 250 µL	1	009990	031804	MULTI-CHAN 10 µL	2
006680	031832	P250-SHIM (TOC)	1	009992	031804	MULTI-CHAN 10 µL	2
006682	031828	P250-S-GT 250 µL	1	009994	031804	MULTI-CHAN 10 µL	2
006683	0318348	P250D-SPARK 250 µL	1	009996	031804	MULTI-CHAN 10 µL	2
006684	0318349	P250D-KONTRON-GT	1	009998	031804	MULTI-CHAN 10 µL	2

Cross Reference Guide

Cross Reference Guide | Hamilton

SGE Replacements for Hamilton Syringes.

Hamilton Part No.	Hamilton Product Code	SGE Part No.	SGE Product Code
80000	1701 N	002200	10F-GT
80011	1701RNHP(26s/51/2)	002250	10R-GT
80020	1702WISP	003990	25D-WISP
80024	1725WISP	006690	250D-WISP
80030	1701RN(26s/51/2)	002250	10R-GT
80065	1701RNR - Rheodyne	002313	10R-GT-LC
80074	175ASN(23s/1.71"/HP)	002812	10F-HP-GT-0.63
80076	175ASN(23s-26s/1.71"/HP)	001821	5F-HP-0.63/0.47
80079	1701ASN(23s-26s/1.71"/HP)	002826	10F-HP-GT-0.63/0.47
80080	1701ASN(23s/1.71"/HP)	002812	10F-HP-GT-0.63
80084	175ASRN(23s/1.71"/HP)	001815	5R-HP-0.63
80086	175ASRN(23s-26s/1.71"/HP)	001825	5R-HP-0.63/0.47
80087	1701ASRN(23s/1.71"/HP)	002818	10R-HP-GT-0.63
80088	1701ASRN(26s/1.71"/HP)	002817	10R-HP-GT-0.47
80089	1701ASRN(23S-26S/1.71"/HP)	002829	10R-HP-GT-0.63/0.47
80090	175ASN(23s/1.71"/HP)pk/6	001814	SK-5F-HP-0.63
80092	175ASN(23s-26s/1.71"/HP)pk/6	001822	SK-5F-HP-0.63/0.47
80094	1701ASN(23s/1.71"/HP)pk/6	002813	SK-10F-HP-GT-0.63
80096	1701ASN(23s-26s/1.71"/HP)pk/6	002827	SK-10F-HP-GT-0.63/0.47
80175	1701ASRN(26s/1.71"/HP)	000400	0.5BR-HP-0.47
80176	1701ASRN(23s/1.71"/HP)	000410	0.5BR-HP-0.63
80200	1702N(22s/51/2)	003200	25F-GT
80230	1702RN(22s/51/2)	003250	25R-GT
80238	1702RNW	003375	25R-WLC-RAX
80262	1702CX	003995	25D-CX-GT
80265	1702RNR - Rheodyne	003312	25R-GT-LC
80300	701N(26s/51/2)	002000	10F
80330	701RN(26s/51/2)	002050	10R
80338	701RN-HP(26s/2"/2)	002050	10R
80350	701SN(26s/2.75"/2)	002003	10F-7
80357	701ASRN(23s/1.71"/HP)	002815	10R-HP-0.63
80358	701ASRN(26s/1.71"/HP)	002805	10R-HP-0.47
80359	80359 (23s-26s/1.71"/HP)	002825	10R-HP-0.63/0.47
80360	901N	002400	10F-GP
80365	701NR - Rheodyne	002301	10F-LC
80366	701N 6p/k	002030	SK-10F
80370	901RN	002450	10R-GP
80387	701ASN(23s/1.71"/HP)	002810	10F-HP-0.63
80388	701ASN(26s/1.71"/HP)	002800	10F-HP-0.47
80389	701ASN(26s/1.71"/HP) Pkt6	002814	SK-10F-HP-0.63
80390	701ASN(23s/1.71"/HP) Pkt6	002804	SK-10F-HP-0.47
80391	701ASN(23s-26s/1.71"/HP)	002822	SK-10F-HP-0.63/0.47
80393	701ASN(23s-26s/1.71"/HP)	002821	10F-HP-0.63/0.47
80400	702N(22s/51/2)	003000	25F
80419	702SN(22/51/3)	003300	25F-LC
80465	702NR - Rheodyne	003300	25F-LC
80500	705N(22s/51/2)	004000	50F
80501	705LT	004229	50F-LT-GT
80530	705RN(22s/51/2)	004050	50R
80551	705CA (50 µL, 2.5")	005236	100F-LT-GT-6.5CA
80565	705NR(22s/51/3)	004300	50F-LC
80600	710N	005000	100F
80601	710LT	005229	100F-LT-GT
80630	710RN	005050	100R
80665	710NR(22s/51/3)	005300	100F-LC
80700	725N(22s/51/2)	006000	250F
80701	725LT	006229	250F-LT-GT
80730	725RN(22s/51/2)	006050	250R
80765	725SNR - Rheodyne	006300	250F-LC
80800	750N	007000	500F
80801	750LT	007229	500F-LT-GT
80830	750RN(22s/51/2)	007050	500R
80865	750SNR - Rheodyne	007300	500F-LC
80900	1705N(22s/51/2)	004200	50F-GT

Hamilton Part No.	Hamilton Product Code	SGE Part No.	SGE Product Code
80901	1705LT	004229	50F-LT-GT
80920	1705TLL	004230	50F-LL-GT
80930	1705RN	004250	50R-GT
80938	1705RNW	004375	50R-GT
80956	1705SL	004279	50R-V-GT
80962	1705CX	004995	50D-CX-GT
80965	1705RNR - Rheodyne	004312	50R-GT-LC
81000	1710N	005200	100F-GT
81001	1710LT	005229	100F-LT-GT
81020	1710TLL	005230	100F-LL-GT
81030	1710RN(22s/51/2)	005250	100R-GT
81056	1710SL	005279	100R-V-GT
81060	1710C	005990	100D-CX-GT
81065	1710RNR - Rheodyne	005312	100R-GT-LC
81100	1725N(22s/51/2)	006200	250F-GT
81101	1725LT	006229	250F-LT-GT
81120	1725TLL	006230	250F-LL-GT
81122	1725TLLX	007230	500F-LL-GT
81130	1725RN	006250	250R-GT
81138	1725RNW	006375	250R-WLC-RAX
81156	1725SL	006279	250R-V-GT
81162	1725CX	006995	250D-CX-GT
81165	1725RNR - Rheodyne	006312	250R-GT-LC
81201	1750LT	007229	500F-LT-GT
81220	1750TLL	007660	500C-HITACHI
81230	1750RN	007250	500R-GT
812560	1750SL	007279	500R-V-GT
81262	1750CX	007995	500D-CX-GT
81265	1750RNR - Rheodyne	007312	500R-GT-LC
81301	1001LT	008020	1 MDF-LT-GT
81320	1001TLL	008025	1 MDF-LL-GT
81330	1001RN(22/51/2)	008100	1 MDR-GT
81356	1001SL	008110	1MDR-V-GT
81360	1001C	008185	1MD-C-GT
81401	1002LT	008420	2.5MDF-LT-GT
81420	1002TLL	008425	2.5MDF-LL-GT
81430	1002RN(22/51/2)	008500	2.5MDR-GT
81456	1002SL	008510	2.5MDR-V-GT
81460	1002C	008687	2.5MD-C-GT
81520	1005TLL	008762	5MDF-LL-GT
81530	1005RN(22/51/2)	008700	5MDR-GT
81610	1010W	008962	10MDF-LL-GT
81630	1010RN(22/51/2)	008900	10MDR-GT
82520	1025TLL	009463	25MDF-LL-GT
84852	801N(26s/51/2)	002400	10F-GP
84853	801RN(26s/51/2)	002450	10R-GP
84877	1801RN(26s/51/2)	002455	10R-GP-GT
85020	1050TLL	009660	50MR-LL-GT
86020	1100TLL	009670	100MR-LL-GT
86274	7000.5ASRN	000400	0.5BR-HP-0.47
86275	7000.5ASRN/PE	000478	0.5BR-PE-0.63
86276	7000.5ASRN	000410	0.5BR-HP-0.63
86311	S0500 (TLL)	009910	500MAR-LL-GT
86312	S1000 (TLL)	009920	1000MAR-LL-GT
86314	S2000 (TLL)	009930	2000MAR-LL-GT
863260	1025SL	009472	25MDR-VLLMA-GT
863360	1050SL	009670	50MR-VLLMA-GT
86346	1100SL	009770	100MR-VLLMA-GT
87402	701RNFS(0.17/10cm/3)	002520	10R-OC-100VS
87900	75N(26s/51/2)	001000	5F
87920	95N 5.0ul SYR (26s/2"/2)	001400	5F-GP
87925	95RN	001450	5R-GP
87930	75RN(26s/51/2)	001050	5R
87939	75N(26/51/5)	001821	5F-HP-0.63/0.47

Expert Tip :

If you can not find an equivalent syringe listed, contact SGE for a suitable replacement.



Cross Reference Guide | Hamilton

Hamilton Part No.	Hamilton Product Code	SGE Part No.	SGE Product Code
87957	75ASRN(23s/1.71"/HP)	001815	5R-HP-0.63
87958	75ASRN(26S/1.71"/HP)	001805	5R-HP-0.47
87959	75ASRN(23s-26s/1.71"/HP)	001825	5R-HP-0.47/0.63
87987	75ASN(23s/1.7"/HP)	001810	5F-HP-0.63
87988	75ASN(26s/1.71"/HP)	001800	5F-HP-0.47
87989	75ASN(26s/1.71"/HP) Pk/6	001804	SK-5F-HP-0.47
87990	75ASN(23s/1.71"/HP) Pk/6	001814	SK-5F-HP-0.63
87993	75ASN(23s-26s/1.71"/HP)	001821	5F-HP-0.63/0.47
87994	75ASN(23s-26s/1.71"/HP) Pkt6	001822	SK-5F-HP-0.63/0.47
88000	7105KH (24/2.75"/3)	000802	5BR-7
88011	7105KH (24/2.75"/2)	000803	5BR-7BV
88035	75ASN/PE-0.63	001954	5F-PE-0.63
88040	75ASN/PE-0.47	001953	5F-PE-0.47
202066	701N Fisons(0.47/80/AS)	002992	10F-C/T-0.47/8C
202201	701N(25s/51/2)	002980	10F-C/T-5/0.47
202315	1702RN w/o needle	003670	25D-HP1090-GT
202325	1725RN w/o needle	006670	250D-HP1090-GT
202400	7005LS (Type B)	001965	5R-SM-7
202640	701RSN-AOC14	002898	10R-S-0.63
202880	701 Varian	002924	10R-VA8X-II
202910	701RNLS	002988	10R-SM-7
203043	1702 CTC(26S/51/AS)	003700	25F-CTC-GT-5/0.47C
203072	701N CTC (26s/2)	002705	10F-CTC-5/0.47BV
203073	701N CTC (22s/3)	002710	10F-CTC-LC
203074	1702 CTC(26/AS) slim line	003980	25F-C/T-0.47C
203075	1702 CTC(22S/51/AS)	003715	25F-CTC-GT-LC
203076	1710 CTC(26S/51/AS)	005700	100F-CTC-GT-5/0.47C
203077	1710 CTC(22S/51/3)	005715	100F-CTC-GT-LC
203078	1725 CTC(26/51/AS)	006700	250F-CTC-GT-5/0.47C
203079	1725 CTC(22/51/3)	006720	250F-CTC-GT-LC (0.4)
203080	1750CTC (26s/AS)	007700	500F-CTC-GT-5/0.47C
203082	1001CTC (23/5)	008130	1MF-CTC-GT-HS-5/0.63H
203084	1002CTC (23/5)	008630	2.5MF-CTC-GT-HS-5/0.63H
203141	1001CTC (26/5)	008135	1MF-CTC-GT-HS-5/0.47H
203181	1002CTC (26/5)	008635	2.5MF-CTC-GT-HS-5/0.47H
203189	75N CTC (26s/AS)	001982	5F-C/T-5/0.47C
203194	1701 CTC(22S/51/3)	002715	10F-CTC-GT-LC
203205	701 N CTC (26s/AS)	002700	10F-CTC-5/0.47C
203235	1710N CTC (22s/3)	005720	100F-CTC-GT-LC (0.4)
203349	1750N CTC (22/3)	007720	500F-CTC-GT-LC (0.4)
203361	701N CTC (23s/AS)	002981	10F-C/T-5/0.63C

Index

Index | By Part Number

SGE Part No.	Page	SGE Part No.	Page	SGE Part No.	Page	SGE Part No.	Page
000300	22, 75	001700	45	002700	45	003312	54, 77
000301	22, 75	001800	43	002705	45	003320	53
000303	22, 75	001804	43	002710	58	003375	55
000310	22, 75	001805	44	002715	58	003600	35
000311	22, 75	001810	43	002800	43	003610	35
000350	22	001814	43	002804	43	003665	44
000353	22	001815	44	002805	44	003668	43, 77
000355	22	001821	43	002810	43	003670	57, 77
000372	32, 75	001822	43	002812	43, 77	003700	45, 77
000376	32, 75	001825	44	002813	43	003715	58, 77
000380	32, 75	001953	47	002814	43	003980	45
000400	44, 76	001954	47	002815	44	003984	58
000410	44, 76	001955	47, 77	002817	44, 77	003985	58, 77
000415	44, 76	001957	47, 77	002818	44, 77	003987	45, 77
000435	48	001981	45, 49	002820	44	003988	46, 77
000440	48, 76	001982	45	002821	43	003989	46
000445	48, 76	001984	46	002822	43	003990	61, 77
000475	47, 76	001987	48	002824	43	003995	66, 77
000478	47, 76	001988	48	002825	44	004...	
000490	46, 49, 76	002...		002826	43, 77	004000	25
000492	46, 49, 76	002000	23	002827	43	004050	25
000500	22, 75	002003	23	002829	44, 77	004090	25
000501	22, 75	002005	23	002830	43	004200	26, 77
000505	22, 75	002007	23	002831	43	004229	26, 77
000506	22, 75	002030	23	002835	43	004230	26, 77
000510	22, 75	002033	23	002838	43	004232	66, 77
000550	22	002035	23	002839	43	004233	77
000553	22	002040	24	002844	44	004250	26, 77
000570	22, 75	002050	23	002845	44	004279	40, 77
000581	50	002055	23	002885	48	004300	53
000582	50	002080	23	002897	48	004310	54
000585	44	002090	24	002898	48	004312	54, 77
000587	44	002100	24	002902	48, 77	004320	53
000610	44, 76	002101	24	002923	51, 77	004375	55
000655	51	002105	24	002924	51, 77	004600	35
000800	22, 75	002108	24	002926	51, 77	004610	35
000801	22, 75	002130	24	002950	51	004665	44
000802	22, 75	002133	24	002965	46	004668	43, 77
000803	22, 75	002135	24	002967	49	004670	47
000804	22, 75	002150	24	002971	45, 49	004682	48
000805	22	002180	24	002972	45, 49	004810	58, 77
001...		002200	26, 77	002976	45	004995	59, 66, 77
001000	23	002202	26	002977	45	005...	
001002	23	002208	26, 77	002980	49	005000	25
001050	23	002250	26, 77	002981	45, 49, 51	005050	25
001090	24	002252	26	002982	46, 49, 51	005055	25
001100	24	002300	53	002983	45	005090	25
001105	24	002301	53	002984	46, 49	005200	26, 77
001150	24	002310	54	002985	46, 77	005229	26, 77
001301	53	002313	54, 77	002986	49	005230	26, 77
001310	54	002315	53	002987	45, 49, 77	005232	66, 77
001400	24	002330	53	002989	49	005236	77
001450	24	002335	53, 77	002991	77	005250	26, 77
001455	24	002345	53	002992	49	005279	40, 77
001490	24	002350	54	002993	49	005291	30
001495	24	002400	24	002996	34	005300	53
001496	34	002450	24	003...		005310	54
001552	32	002453	24	003000	25	005312	54, 77
001554	32	002455	26, 77	003050	25	005320	53
001560	32	002490	24	003090	25	005330	58, 77
001565	32	002493	24	003200	26, 77	005331	77
001570	32	002500	26, 32, 77	003250	26, 77	005333	46, 77
001585	32	002520	32	003300	53	005335	45, 77
001587	32	002684	50	003310	54	005337	46

SGE Part No.	Page
005375	55
005600	35
005610	35
005665	44
005668	43, 77
005700	45, 77
005715	58
005720	58, 77
005921	51, 77
005990	59, 66, 77
006...	
006000	25
006050	25
006200	26, 77
006229	26, 77
006230	26, 77
006232	66, 77
006250	26, 77
006279	40, 77
006291	30
006292	30
006300	53
006310	54
006312	54, 77
006320	53
006330	58, 77
006375	55
006600	35
006610	35
006660	60, 77
006665	44
006670	57, 77
006680	67, 77
006682	48, 77
006683	59, 77
006684	77
006690	61, 77
006700	45, 77
006720	58, 77
006995	59, 66, 77
007...	
007000	25
007050	25
007090	25
007200	26, 77
007229	26, 77
007230	26, 77
007232	66, 77
007250	26, 77
007279	40, 77
007300	53
007310	54
007312	54, 77
007320	53
007375	55
007600	35
007610	35
007630	77
007660	57, 77, 60
007680	77
007684	77
007700	45, 77
007720	58, 77
007995	59, 66, 77

SGE Part No.	Page
008...	
008020	27, 65, 67, 77
008025	27, 63, 65, 66, 77
008100	27, 65, 77
008102	27, 65, 77
008105	54, 77
008110	40, 77
008120	58, 77
008130	45
008135	45
008140	77
008160	40, 77
008170	37
008171	37
008180	60
008183	59, 77
008184	77
008185	59, 66, 77
008195	77
008199	77
008420	27, 65, 77
008425	27, 63, 65, 66, 77
008500	27, 65, 77
008502	27, 65, 77
008505	54, 77
008510	40, 77
008560	40, 77
008584	77
008620	58
008630	45
008635	45
008660	60, 77
008685	77
008687	59, 66
008692	77
008700	27, 65, 77
008760	27, 65, 77
008762	27, 63, 65, 66, 77
008770	40, 77
008775	36, 77
008780	60, 77
008785	77
008787	66, 77
008790	67, 77
008792	67, 77
008820	58, 77
008900	27, 65, 77
008960	27, 65, 77
008962	27, 63, 65, 77
008970	40, 77
008975	36, 77
008985	77
008987	66, 77
008992	67, 77
009...	
009462	27, 65, 77
009463	27, 63, 65, 66, 77
009472	40, 77

SGE Part No.	Page
009485	77
009660	27, 65, 77
009670	40, 77
009760	27, 65, 77
009770	40, 77
009910	33
009920	33
009930	33
009990	77
009992	77
009994	77
009996	77
009998	77
030...	
030025	41
030040	41
030045	41
030200	33, 41
030240	41
030245	41
030260	41
030265	41
030900	41
030905	41
030920	41
030930	33, 41
030950	41
030952	41
031...	
0312170	27, 40, 65
0312176	27, 40, 65
031218	51
031512	34
031513	34
031516	27, 65, 74
031521	74
0315233	74
0315234	74
031525	58
031535	49
031571	36
0315720	37
0315722	37
031745	71
031746	71
031747	71
031776	69
031780	70
031781	70
031782	71
031786	69
031798	48
031803	45, 49, 58
031805	26
031807	47
031808	43
031809	44
031810	26, 53
031811	26, 32, 54
0318121	46
031815	26, 54
031816	46, 58
031817	45
031818	43

SGE Part No.	Page
0318181	57
031819	61
0318191	66
031820	26, 40, 54
031821	58
031822	43
0318221	59, 66
031823	43
031824	51
031825	26, 40, 54
031826	30, 45, 46, 58
0318261	58
0318271	59, 66
031828	48
031829	57
031830	26, 40, 54
0318301	30
031831	30, 58
031832	67
031833	60, 66
031834	61
0318341	59
0318348	59
031835	26, 40, 54
031837	57
031838	60
0318381	59, 66
031842	27, 40, 54, 65, 67
031844	60
0318441	27, 45, 59, 63, 65, 66
0318444	58
0318448	59
0318451	45
0318454	58
031852	27, 40, 54, 63, 65, 66
031853	60
031854	59, 66
031856	27, 40
031856	60, 65
0318562	27, 63, 65, 66, 67
0318564	58
031857	36
031858	67
0318591	66
031862	27, 36, 40, 65
0318631	66
031864	27, 63, 65, 66, 67
031870	27, 40, 65
031874	27, 63, 65, 66
0318921	45, 58
0318924	58
0318926	45, 58
0318928	45, 58
031902	33, 76
031903	76
031905	39, 40
031906	39



Index | By Part Number

SGE Part No.	Page	SGE Part No.	Page	SGE Part No.	Page	SGE Part No.	Page
031907	39, 40	036110	24, 73	037787	46, 49, 74	039831	74
031910	39, 40	036130	24, 73	037995	34	039842	74
031911	39	036160	73	038...		039847	74
031915	39	036250	54, 73	038030	74	039851	74
031930	69	036310	73	038060	74	039862	74
032...		036410	73	038110	19, 25, 26, 35, 74	039867	74
032002	76	036510	73	038111	74	039871	74
032004	76	036530	73	038130	25, 74	039880	74
032012	76	036603	73	038131	74	039891	74
032014	76	036605	73	038160	74	039895	74
032016	76	036610	32, 73	038161	74	039897	74
032018	76	036625	73	038250	54, 58, 74	041...	
032030	76	036635	32, 73	038251	53	041822	33
032040	76	036651	32, 73	038252	54	073...	
032042	76	036675	32, 73	038253	54	0730018	41
032044	33	036685	32, 73	038254	53	0730019	41
032527	33	036701	32, 73	038255	54	290...	
032532	33	036703	32, 73	038256	54	2900101	30
032537	33	036710	44, 73	038257	53	2900102	30
033...		036720	44, 73	038258	54	2900103	30
033010	22, 75	036730	44, 73	038259	54	2900104	30
033011	22, 75	036910	19	038260	53, 55, 74	2900105	30
033012	22, 75	036912	19	038261	54	2900106	30
033057	22, 75	036914	19	038262	54	2900301	30
033060	22, 75	036916	19	038263	53	2900302	30
033605	75	036918	19	038265	61	2900303	30
033610	32, 75	036953	34	038270	74	2900304	30
033620	32, 75	037...		038310	74	2900305	30
033630	32, 75	037010	73	038410	74	2900306	30
033708	44, 76	037011	73	038420	46	2900401	30
033715	44, 76	037013	46	038430	74	2900402	30
033730	44, 76	037030	73	038460	74	2900403	30
033732	48	037031	73	038510	74	2900404	30
033738	48, 76	037060	73	038530	74	2900405	30
033745	48, 76	037110	23, 24, 26, 73	038717	44, 74	2900406	30
033750	47, 76	037111	73	038730	74	2900408	30
033765	47, 76	037130	23, 24, 73	038732	46, 74	2900409	30
033770	46, 49, 76	037160	74	038735	74	2900501	30
033772	46, 49, 76	037250	53, 54, 73	038736	46	2900502	30
034...		037260	73	038745	51, 74	2900503	30
034055	22, 75	037270	73	038749	46	2900504	30
034056	22, 75	037310	73	038810	39, 40	2900505	30
034057	22, 75	037330	50, 73	038815	40	2900506	30
034059	22, 75	037410	73	038820	39, 40	2900508	30
034060	22, 75	037510	73	038910	74	2900509	30
034610	22, 75	037540	73	039...		291...	
034705	44	037605	73	039110	19, 27, 65, 74	2910000	19
034710	44	037610	32, 73	039116	74	2910005	19
034715	44, 76	037675	26, 32, 73	039130	74	2910010	19
034720	51	037715	44, 73	039160	74	2910012	19
034770	50	037717	44, 73	039180	58	2910020	19
034772	50	037730	44, 73	039182	58	2910021	19
035...		037736	48, 74	039250	54, 74	2910022	19
035055	22, 75	037745	48, 74	039260	74	2910023	19
035056	22, 75	037747	48, 74	039802	36, 74	2910024	19
035057	22, 75	037775	51, 74	039803	36, 74	2910025	19
035058	22, 75	037776	74	039807	74	2910030	19
035059	22, 75	037777	51, 74	039808	74	2910040	19
035060	22	037778	74	039811	74	2910380	19
036...		037779	74	039822	74	2910382	19
036010	73	037780	74	039823	74	2910384	19
036011	46, 73	037785	46, 49, 51, 74	039827	74		
036030	73						
036031	73						

Index | By Product

Description	Page
A	
Accessories	68-71
Agilent Technologies	43-44, 57
Agilent Technologies GC Autosampler Syringes	43-44
Agilent Technologies LC Autosampler Syringes	57
Altex	53-54
Autosampler Syringes	1, 42-51, 56-61
Autosampler Syringes – GC	42-51
Autosampler Syringes – LC	56-61
B	
Barrel Internal Diameter (ID)	9
Beckman	53-54
C	
Calibration	11
Care	7
Certificates – Conformance and Calibration	11
Cleaning	7, 8
Cleaner – Heated Syringe Cleaner	8
Color Coding	14
Conformance	11
CTC Analytics	45-46, 58
D	
Diamond Syringe Technology	13
Diluter/Dispenser Syringes	27, 65
E	
eVol® - Digitally Controlled Analytical Syringe	17-19
eVol® Syringes and Accessories	19
F	
Fixed Needle Syringes	2, 3, 23-27, 35, 43, 45, 47-49, 53, 58
G	
Gas Sealing Gland Syringes	35
Gas Tight Syringes – see PTFE Tipped Plunger Syringes	
GC Autosampler Syringes	42-51
GC Manual Syringes	21-27
GC Syringes	21-27, 42-51
General Purpose Syringes	21-27
Grabner Instrument Syringes	67
H	
Hamilton Instrument Syringes	66
Hamilton Syringe Cross Reference	78-81
Headspace/ Soil Gas Syringes	36
Heated Syringe Cleaner	70
High Pressure Syringes	37
Hitachi	57
I	
Instrument Syringes	64-67
J	
Jumbo Syringes	33
L	
Large Volume Syringes – see Jumbo Syringes	33
LC Autosampler Syringes	56-61
LC Manual Syringes	52-55
LC Pump Priming Syringes	62-63
LC Syringes	52-63
Luer Lock/Luer Tip	2, 27, 39-40, 63, 65-67

Description	Page
M	
Maintenance	7
Manual Syringes	1, 21-37, 53-55
MEPS™ (Micro Extraction by Packed Sorbent)	29-30
Microsyringe/Pipette	34
N	
NanoVolume Syringes	21
Needles	3
Replacements	73-74, 75-76
Needle Care	8
Needle Cleaning Kit	8, 71
Needle Selection	4
Needle Tip Styles	4
O	
On-column Syringes	31-32
P	
Part Number Index	83
PerkinElmer	47, 59
Plunger Tips	5
Plunger-in-Needle - see NanoVolume Syringe	5, 21
Plungers	5
Replacement Plungers	77
PTFE Tipped Plungers Syringes	
10 µL - 500 µL	26
1 mL - 100 mL	27, 65
R	
Rack	69
Removable Needle	2, 3
Repeating Adaptor – RAX	69, 22, 24, 25, 53
Replacement Guide (Hamilton)	78-81
Replacement Needles	73-74
Replacement Plunger and Needle Kits (NanoVolume Syringes)	75-76
Replacement Plungers	77
Rheodyne	53
S	
SealTight™ Valves	41
Shimadzu	48, 67
Spark Holland	59
Special Purpose Syringes	5, 28
SSI Instruments	53-54
Stylet Wires	71
Syringe	
Accessories	68-71
Calibration	11
Care	7
Certificates – Conformance and Calibration	11
Cleaning	7, 8
Cleaner – Heated Syringe Cleaner	8
Color Coding	14
Components	76
Conformance	11
Cross Reference	78-81
Digitally Controlled	17-19
eVol®	19
Fixed Needle	2, 3, 23-27, 35, 43, 45, 47-49, 53, 58



Index | By Product

Gas Sealing Gland	35
Gas Tight – see PTFE Tipped Plunger	
GC	21-27, 42-51
GC Autosampler	42-51
GC Manual	21-27
General Purpose	21-27
PTFE Tipped Plunger 10 µL - 500 µL	26
PTFE Tipped Plunger 1 mL - 100 mL	27, 65
Metal Plunger 25 µL - 500 µL	25
Metal Plunger 5 µL - 10 µL	23-24
NanoVolume 0.5 µL - 5 µL	21
Headspace/ Soil Gas	36
Cleaner	70
High Pressure	37
Jumbo	33
LC	52-63
LC Autosampler	56-61
LC Manual	52-55
LC Pump Priming	62-63
Maintenance	7
Manual	1, 21-37, 53-55
MEPS™ (Micro Extraction by Packed Sorbent)	29-30
Microsyringe/Pipette	34
NanoVolume	21
On-column Syringes	31-32
Rack	69
Removable Needle	2, 3, 22-27, 32, 35, 44, 46-51, 53-55, 58, 65
Repeating Adaptor – RAX	69, 22, 24, 25, 53
Replacement Needles	73-74
Replacement Plunger and Needle Kits (NanoVolume Syringes)	75-76
Replacement Plungers	77
Selection	1
Structure	9-10
Temperature Specifications	7
Termination	2
Troubleshooting	10
Use	8
Validation	11
Valves	38-40, 41
Syringes for:	
Agilent Technologies	43-44, 57
Altex	53-54
Autosamplers	1, 42-51, 56-61
Autosampler Syringes – GC	42-51
Autosampler Syringes – LC	56-61
Beckman	53-54
CTC Analytics	45-46, 58
Diluter/Dispensers	27, 65
General Purpose Use	21-27

Grabner Instruments	67
Hamilton Instruments	66
Hitachi Instruments	57
Instruments	64-67
PerkinElmer Instruments	47, 59
Rheodyne Instruments	53
Thermo Scientific Instruments	49, 60
Unicam Instruments	50
Valco Instruments	53-54
Varian Instruments	51
Waters Instruments	55, 61
Zymark Instruments	67
T	
Technical Information	6
Temperature Specifications	7
Termination	2
Thermo Scientific	49, 60
Troubleshooting	10
U	
Unicam Instruments	50
V	
Valco	53-54
Validation	11
Valves	38-40, 41
SealTight™ Valves	41
Varian Instruments	51
Volume	1
W	
Waters Instruments	55, 61
WISP	61
X	
XCHANGE® – Robotics	16
XCHANGE® – Syringes for eVol®	19
Z	
Zymark Instrument Syringes	67

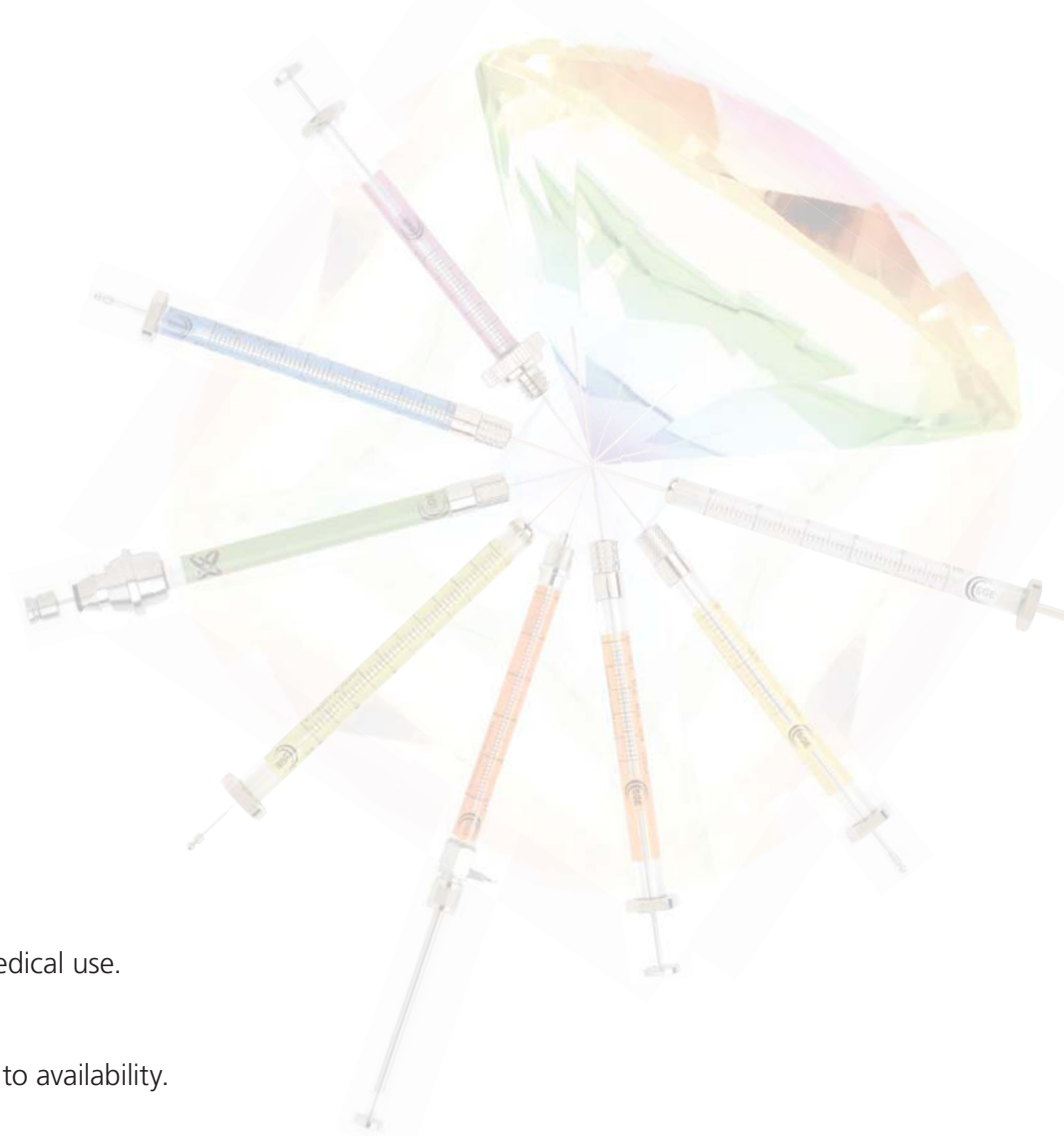

Disclaimers

SGE Products

Our products are not suitable for medical use.

Availability

All SGE products shown are subject to availability.

Continuous Improvements

SGE is continually developing and improving our products. SGE reserves the right to change product specifications without notice.

Returns

In consideration of the health and wellbeing of our employees, SGE products contaminated by hazardous materials **MUST NOT BE RETURNED**.

Errors

The information published in this catalogue is, to the best of our knowledge, correct and accurate, but is not guaranteed to be so. SGE assumes no responsibility in this respect.

Product Warranty

SGE products are warranted to meet the stated quality and performance and to be free of defects in material or workmanship for a period of forty five (45) days from the date of shipment. The warranty implies free replacement of a defective product only upon proper written proof of the defect and upon return of the defective product. It does not apply to mishandling of product by the customer, either in use or in storage, or to claims made after the warranty period has elapsed. No warranty or representation is expressed or implied by SGE for its products with respect to merchantability, fitness for any particular use or purpose, or any other matter. SGE shall not, under any circumstances, be liable for any incidental, consequential, or compensatory damages arising from use of or in conjunction with its products. The maximum liability for breach of warranty shall be the invoice price of the said product(s).

Trademarks

Mentioned trademarks are registered trademarks of their respective owners. No license or immunity under any patent is granted or implied by our sale of any material.

AUSTRALIA & PACIFIC REGION

SGE Analytical Science Pty Ltd
7 Argent Place, Ringwood
Victoria 3134 Australia

Toll Free: 1800 800 167
Tel: +61 (0) 3 9837 4200
Fax: +61 (0) 3 9874 5672
Email: support@sge.com

CHINA

SGE Shanghai Representative Office
Room 8221A, No. 808 Hongqiao Road
Shanghai China

Tel: +86 21 6407 9382
Fax: +86 21 6407 9386
Email: china@sge.com

MIDDLE EAST

SGE Gulf
Y2 - 133, Sharjah Airport International
Free Zone (SAIF Zone)

P.O. Box 9377, Sharjah, UAE
Tel: +971 6 557 3341
Fax: +971 6 557 3541
Email: gulfsupport@sge.com

EUROPE

SGE Europe Ltd
European Head Office
1 Potters Lane

Kiln Farm Milton Keynes
MK11 3LA United Kingdom
Toll Free: 00800 2790 8999
Toll Free Fax: 00800 2626 2609
Tel: +44 (0) 1908 568 844
Fax: +44 (0) 1908 566 790
Tel France: +33 (0)1 69 29 80 90
Fax France: +33 (0)1 69 29 09 25
Tel Germany: +49 (0) 6155 / 60746 0
Fax Germany: +49 (0) 6155 / 60746 50
Email: europe@sge.com

INDIA

SGE Laboratory Accessories Pvt Ltd
209 Milan Industrial Estate
Abhudaya Nagar T. J. Road
Mumbai - 400 033 India

Tel: +91 22 24715896
Fax: +91 22 24716592
Email: sgeindia@vsnl.com

UNITED STATES OF AMERICA

SGE Incorporated
2007 Kramer Lane
Austin Texas 78758 USA

Toll Free: (800) 945 6154
Tel: +1 512 837 7190
Fax: +1 512 836 9159
Email: usa@sge.com

JAPAN

SGE Japan Inc
RK CUBE 3F 6-85, Ohta-machi
Naka-Ku, Yokohama-shi
Kanagawa 231-0011 Japan

Tel: +81 45 222 2885
Fax: +81 45 222 2887
Email: japan@sge.com

